

POWERED BY **EMEC**

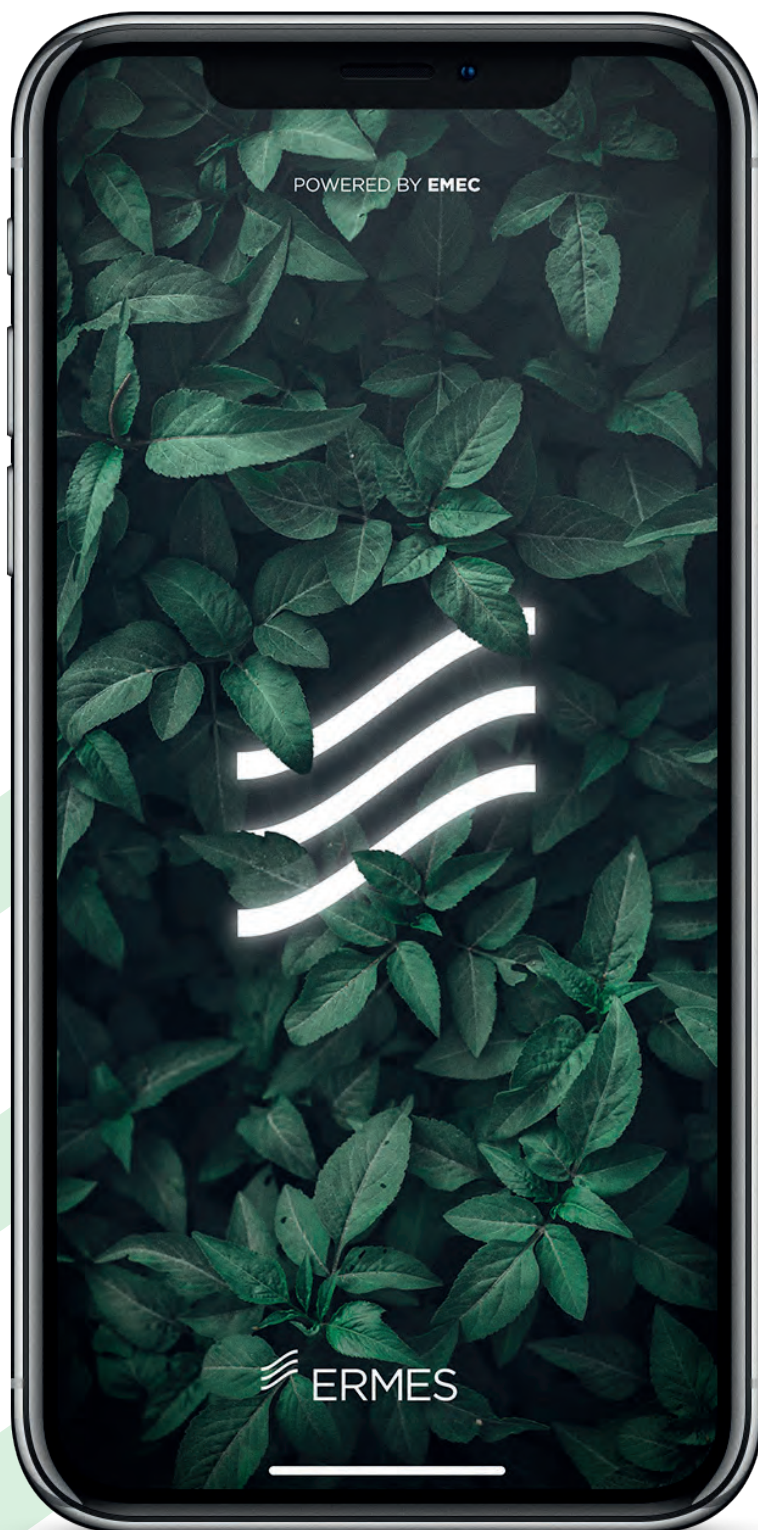

 **ERMES**

REMOTE MEASUREMENT AND CONTROL



ERMES



Remote measurement and control

Through ERMES online service you can remotely control and regulate all the parameters of all EMEC enabled products and interactively monitor probes, instrument inputs, products level, temperature and setpoints.

ADVANTAGES

- Less plant intervention and inspections.
- Reports on the current status of the network's devices and connections (probes, outputs, alarms, setpoints)
- Instant alarm notifications via sms or email
- Data report of all plant systems
- Activity log like graphs and charts that can be downloaded on your PC (excel or pdf)

HOW DOES ERMES WORK?

Enter www.ermes-server.com, register for free, configure and name your systems. All EMEC controllers with encoder and ETHERNET or 3G/4G configuration will be immediately connected and available.

In addition to the remote control, through ERMES you can receive, via email, alarm messages with various report options on the status of your systems.

If you have an controller with 3G/4G configuration you can also receive reports on your phone via SMS.

On request, the controllers can be supplied with a SIM card and mobile data subscription (only on controllers equipped with a 3G/4G module. Subscription paid by the customer).

EMEC COMPATIBLE SYSTEMS

- LD
- MAX 5
- M-TOWER
- WD
- CENTURIO

CONFIGURATION	FEATURES	CONNECTION TYPE	REQUIREMENTS	FUNCTIONS
BASIC	/	/	/	RS485 link to EMEC instruments
ADVANCED USB	USB	Download data log from controller to Usb drive	/	RS485 link to other EMEC instruments Data Log recording on USB drive
ETHERNET	LAN network	Remote control via WEB APP ERMES (www.ermes-server.com)	LAN (RJ-45) network	RS485 link to other EMEC instruments ERMES Web App (PC, smartphone, tablet) Email Alarm messages
3G/4G	MOBILE connection	Remote control via WEB APP ERMES (www.ermes-server.com)	Mobile Network Coverage	RS485 link to other EMEC instruments ERMES Web App (PC, smartphone, tablet) Email/SMS Alarm messages
MODBUS	PLC connection to other devices via RS485 or TCP/IP (only Centurio)	PLC plant management	/	PLC connection output for parameters reading/setting
WIFI	WIFI connection between instrument and web	Remote control via WEB APP ERMES (www.ermes-server.com)	WIFI Network Coverage	RS485 link to other EMEC instruments ERMES Web App (PC, smartphone, tablet) Email Alarm messages

Ethernet - Wifi

CONNECTION EXAMPLE

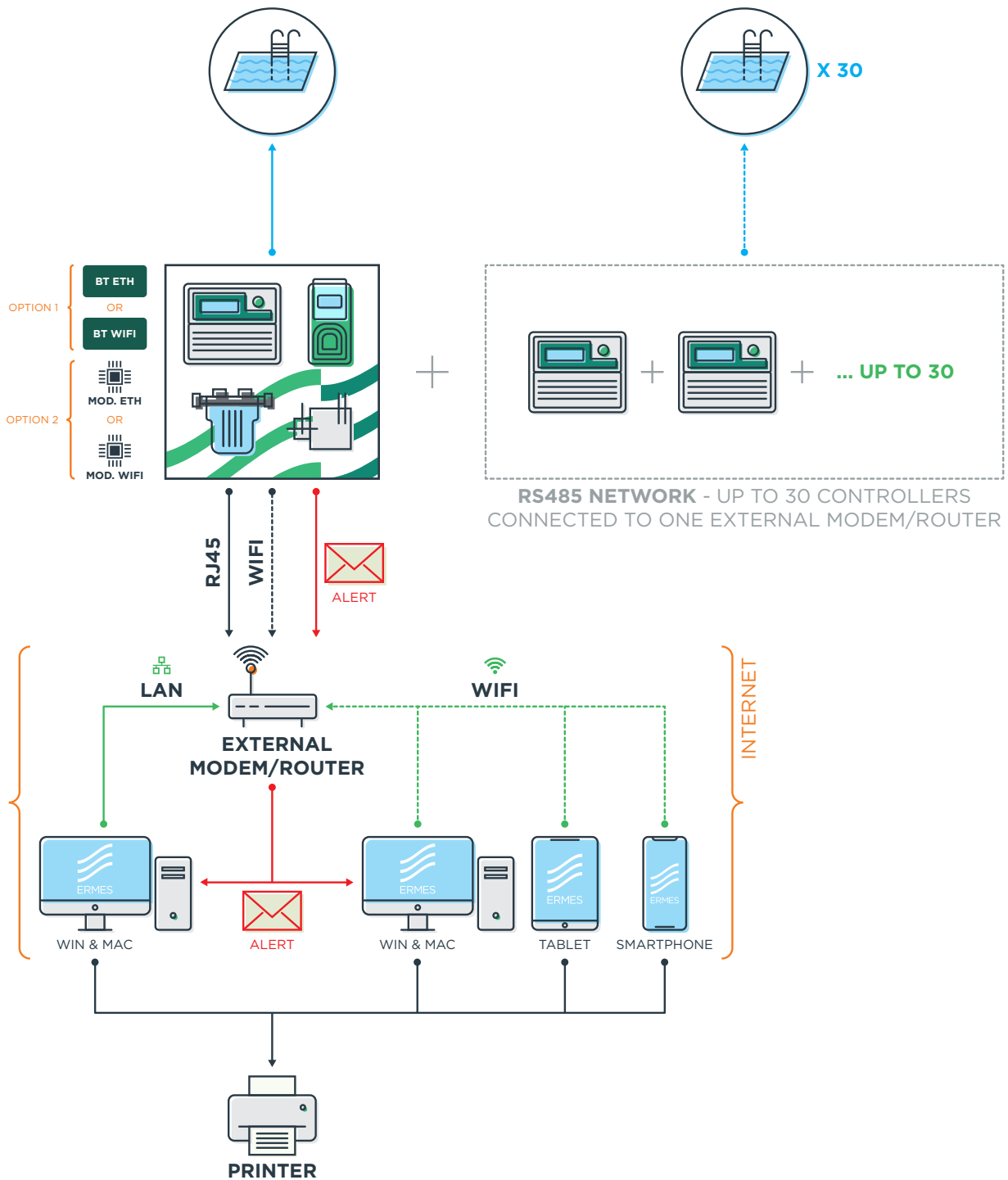

GSM - 3G/4G CONNECTION EXAMPLE

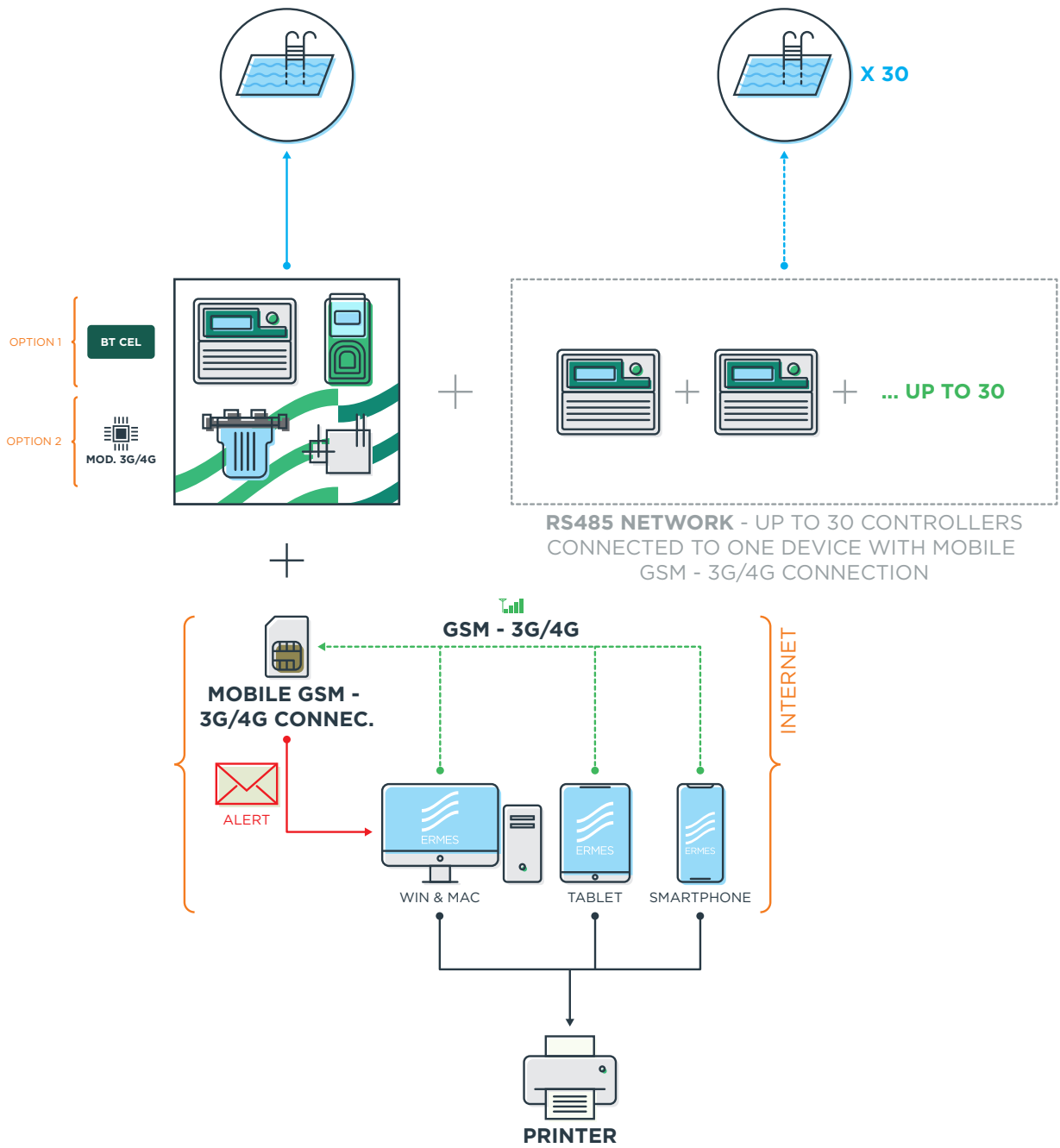



Data download & upload via USB

CONNECTION EXAMPLE

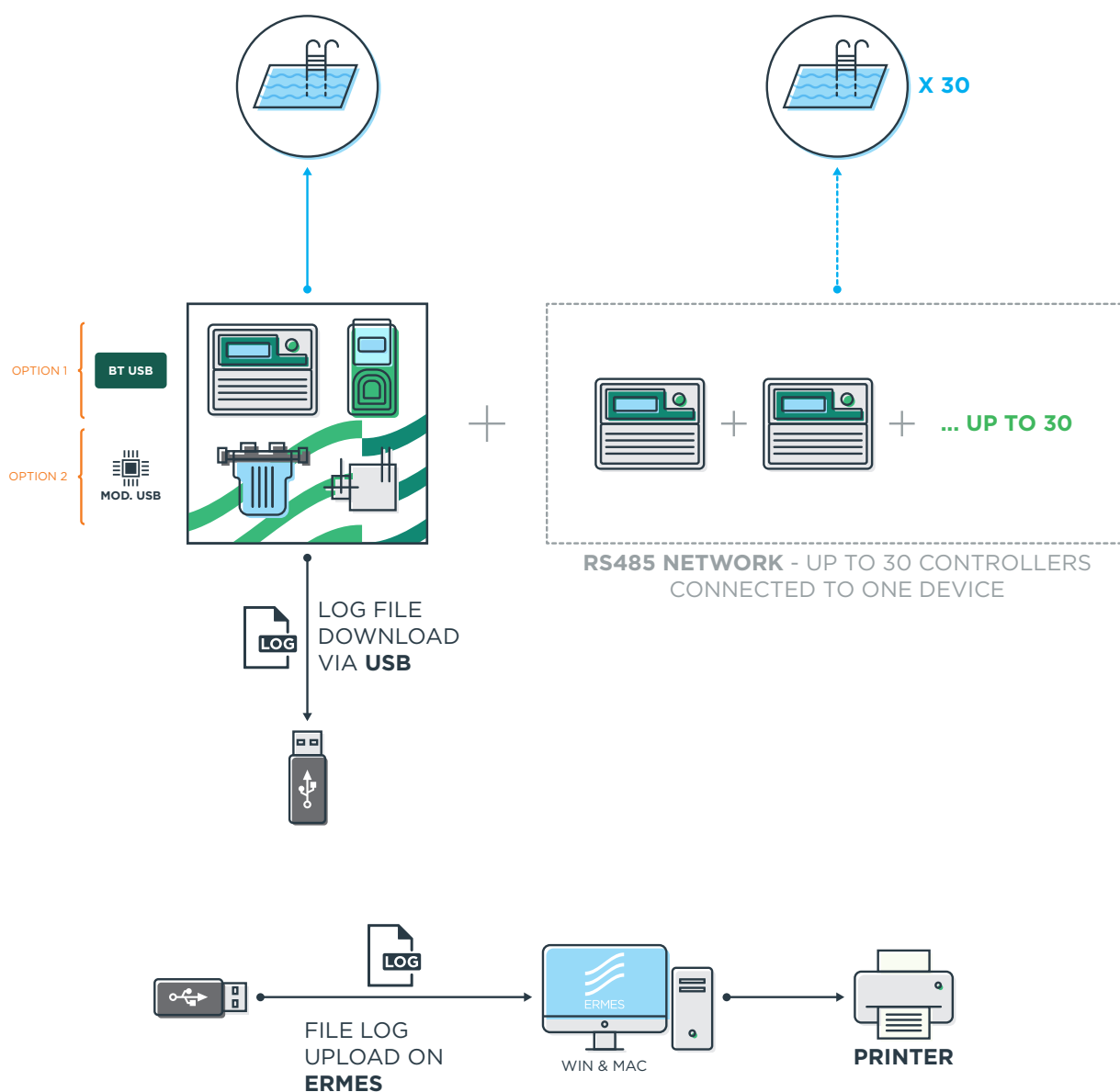



Modem and external communication modules

For LD, MAX 5, M-TOWER, WD and CENTURIO controller series

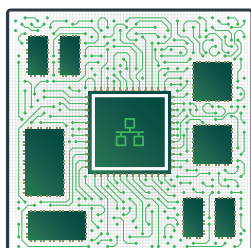

ETHERNET MODULE
Internal standard ETHERNET (RJ45) controller for LD encoder and MAX5 controllers.

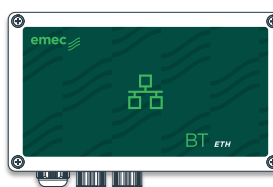

BT ETH
Ethernet controller for standard RJ45 network. IP65.

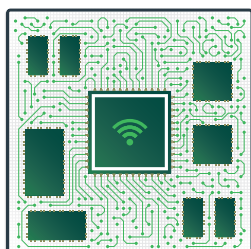

WIFI MODULE
Module for WIFI network. IP65.



BT WIFI
Module for WIFI connection. IP65.

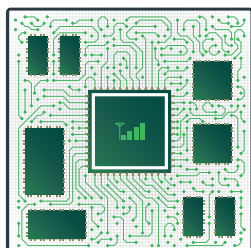

3G/4G MODULE
Internal 3G/4G modem for LD encoder and MAX5 controllers.



BT CEL
Modem for mobile network. IP65.

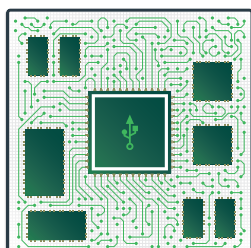

USB MODULE
Module for USB connection. IP65.

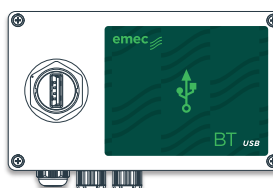

BT USB
USB module for USB datalog recording. IP65.

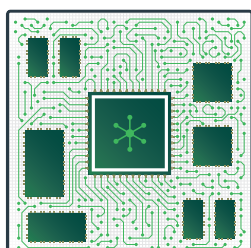

MODBUS MODULE
MODBUS RTU module for PLC connection.



BT MODBUS
Serial communication module for PLC connection.



Modbus

INTERNAL MODEM CONNECTION SCHEME

- IN THE **COMMUNICATION** MENU OF THE CONTROLLER SET RS485 ID TO **01**
- CONNECT THE 2 WIRES OF THE RS485 ON THE MODBUS MODULE RESPECTING **(+)** AND **(-)** AND SEND THEM TO THE PLC

- SET THE **MODBUS ID** AND **BAUD RATE** IN THE MODBUS MENU OF THE CONTROLLER

On older controllers, to maintain consistency with the manual, the parameters request must be made one register at a time, otherwise they will be shifted by one value.

Master (PLC)

Modbus

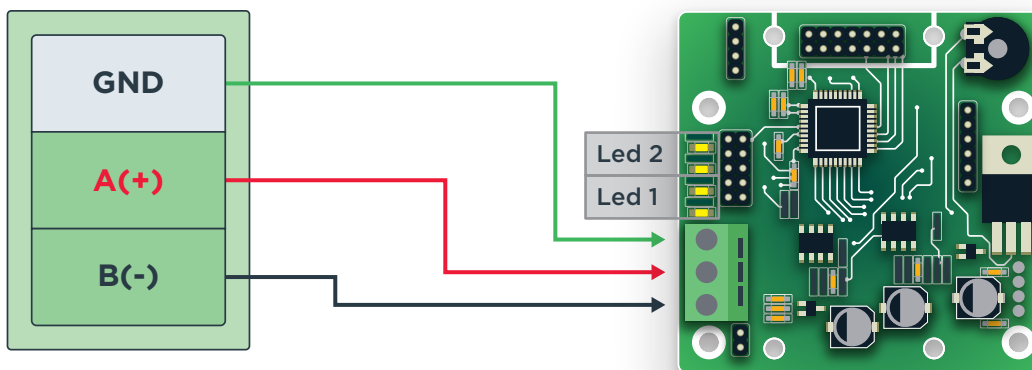

Modbus

EXTERNAL MODEM CONNECTION SCHEME (BT MODBUS)

- IN THE **COMMUNICATION** MENU OF THE CONTROLLER SET RS485 ID TO **01**
- CONNECT THE RS485 OF THE CONTROLLER TO THE RS485 OF THE BT MODBUS RESPECTING **(+)** AND **(-)**
- CONNECT THE RS485 OF THE MODBUS MODULE INTEGRATED IN THE BT MODBUS TO THE PLC, RESPECTING **(+)** AND **(-)**

- SET THE **MODBUS ID** AND **BAUD RATE** IN THE MODBUS MENU OF THE CONTROLLER

On older controllers, to maintain consistency with the manual, the parameters request must be made one register at a time, otherwise they will be shifted by one value.

BT Modbus

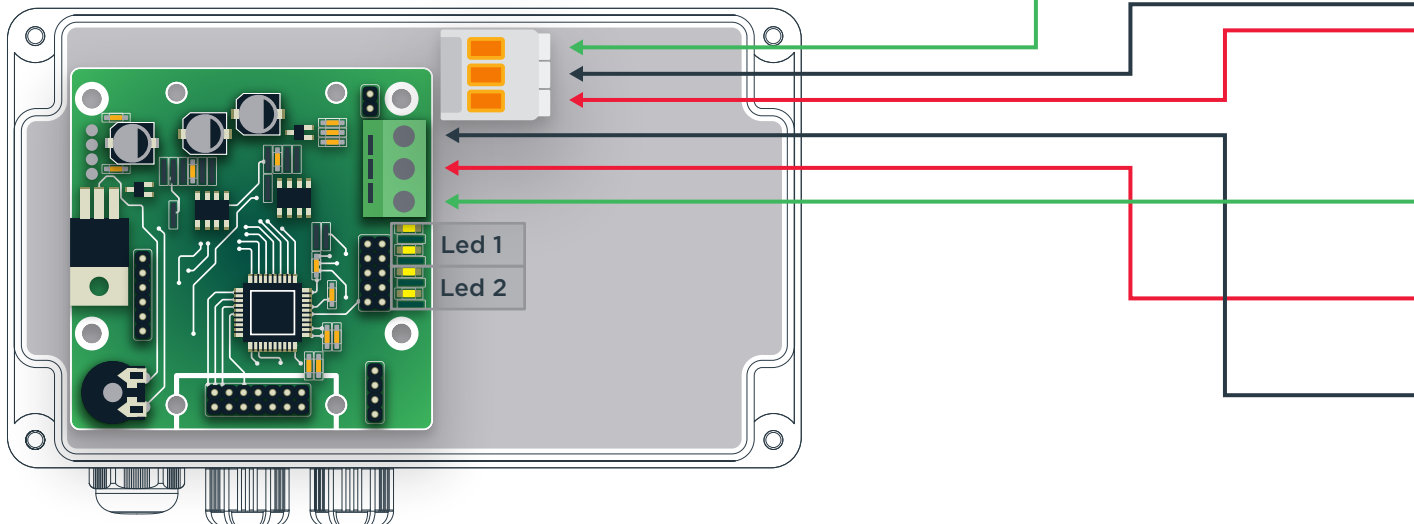



MODBUS Connection Example

INTERNAL / EXTERNAL (BT MODBUS) MODEM

Below an example of a protocol for requesting only the measurement value of Channel 1 (e.g. pH):

Modbus address 40002, ID slave:01

Protocol string to be sent (hexadecimal encoding):

[01][03][00][01][00][01][D5][CA]

Response example:

[01][03][02][02][E4][B9][6F]

The value of the measure relating to channel 1 with hexadecimal code is highlighted.

Decoding:

0x02E4(Hex) => 740(dec)

740 / 100 = 7.40 pH

PUMPS AND CONTROLLERS MODBUS NATIVE

- In the Modbus menu, set: Modbus ID, Baud rate, parity, stop bits and the number of bits of the Modbus network where the Control Unit is integrated.
- The registers can also be read in multiple form with a maximum of 128 registers.

CONTROLLERS AND PUMPS EQUIPPED WITH MODBUS MODULE

- Controller/pump equipped with Modbus module.
- Each control unit must have its own MODBUS module, internal or external in the form of BT MODBUS.
- It is not possible to connect additional control units in RS485 with a single module.
- Check the flashing of the LED as shown in the image.
- Values that cannot be set in the control unit are parity, stop bits and the number of bits. These values must be set as follows:

Parity: NO

Stop: 1

Bits number: 8

- The communication between MODBUS module and controller is signaled through the pair of LEDs highlighted as LED1.
- *Led 1: The pair of LEDs flashes if there is communication between the Modbus module and the controller (frequency about 20 sec)*
- The communication between the MODBUS module and any PLC is signaled through the pair of LEDs highlighted as LED2.
- *Led 2: The pair of LEDs blinks if there is communication between the Modbus module and the Master (e.g. PLC).*
- If the controller has the Modbus module it is not possible to put other communication modules on the same controller (USB, GPRS, WIFI, ETH).
- It is possible to verify the correct functioning of the MODBUS module output to the PLC by installing the MODBUSMAT program on a PC and using an RS485-USB converter.

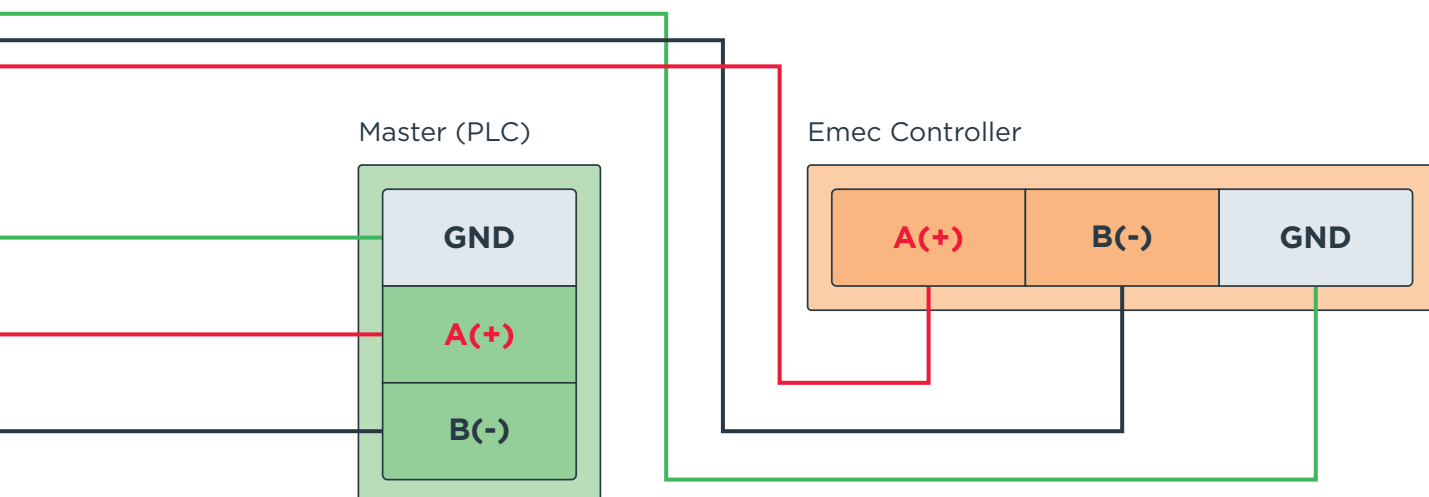



EMEC S.r.l. Via Donatori di Sangue, 1 - 02100 Rieti - Italia

T. +39 0746 2284 1 F. +39 0746 2284 2

info@emecpumps.com - www.emecpumps.com