

CEN-A

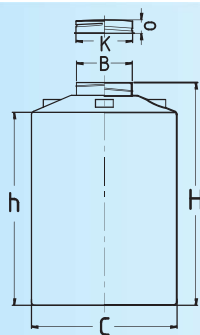

TISI 1379-2551



Top View

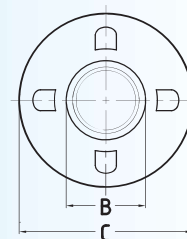

Tank							Lid				Approx. Total Weight (kg)
Part Number	Capacity (Litre)	Approx. Dimension (mm.)					Part Number	Approx. Dimension (mm.)			
		B	C	H	h	Thk.		K	O	Thk.	
CEN1K0A-M141	1,000	395	1,030	1,575	1,365	5.0	CT0395A-M1X8	395	90	3.0	30.70
CEN1K0A-M144						5.5					33.70
CEN1K0A-M156						7.5					45.70
CEN1K0A-M168						9.5					57.70
CEN1K5A-M155	1,500	395	1,300	1,530	1,280	5.5	CT0395A-M1X8	395	90	3.0	44.70
CEN1K5A-M159						6.0					48.70
CEN1K5A-M167						7.0					56.70
CEN1K5A-M180						10.0					79.70
CEN2K0A-M168	2,000	395	1,300	1,900	1,650	6.0	CT0395A-M1X8	395	90	3.0	57.70
CEN2K0A-M178						7.0					67.70
CEN2K0A-M188						8.0					77.70
CEN2K0A-M107						10.0					96.70
CEN2K5A-M174	2,500	395	1,300	2,150	1,900	6.0	CT0395A-M1X8	395	90	3.0	63.70
CEN2K5A-M184						7.0					73.70
CEN2K5A-M195						8.0					84.70
CEN2K5A-M211						10.0					100.70
CEN3K0A-M180	3,000	395	1,300	2,650	2,400	6.0	CT0395A-M1X8	395	90	3.0	79.00
CEN3K0A-M103						7.0					92.00
CEN3K0A-M216						8.0					105.00
CEN3K0A-M242						10.0					131.00
CEN4K0A-M231	4,000	500	1,600	2,450	2,150	8.0	CT0500A-M2X9	500	150	3.0	121.70
CEN4K0A-M261						10.0					151.70
CEN4K0A-M271						11.0					161.70
CEN4K0A-M201						13.0					191.70
CEN4K0A-M331						15.0					221.70
CEN6K0A-M281	6,000	500	1,850	2,830	2,410	8.0	CT0500A-M2X9	500	150	3.0	171.70
CEN6K0A-M321						11.0					211.70
CEN6K0A-M361						13.0					251.70
CEN6K0A-M301						15.0					291.70
CEN10K0A-M411	10,000	500	2,100	3,680	3,250	11.0	CT0500A-M2X9	500	150	3.0	301.70
CEN10K0A-M461						13.0					351.70
CEN10K0A-M511						15.0					401.70
CEN10K0A-M571						17.0					461.70
CEN10K0A-M501						18.0					491.70
CEN15K0A-M501	15,000	500	2,500	3,680	3,300	14.0	CT0500A-M2X9	500	150	3.0	491.70
CEN15K0A-M671						16.0					561.70
CEN15K0A-M741						18.0					631.70
CEN15K0A-M811						20.0					701.70
CEN20K0A-M719	20,000	500	2,500	4,760	4,380	14.0	CT0500A-M2X9	500	150	3.0	680.00
CEN20K0A-M891						16.0					780.00
CEN20K0A-M981						18.0					870.00
CEN20K0A-M081						20.0					970.00
CEN24K0A-M719	24,000	500	2,500	5,380	5,000	14.0	CT0500A-M2X9	500	150	3.0	680.00
CEN24K0A-M891						16.0					780.00
CEN24K0A-M981						18.0					870.00
CEN24K0A-M081						20.0					970.00
CEN25K0A-M898	25,000	500	2,500	5,930	5,450	14.0	CT0500A-M2X9	500	150	3.0	784.00
CEN25K0A-M902						16.0					896.00
CEN25K0A-M2119						18.0					1008.00
CEN25K0A-M2231						20.0					1120.00

NOTE: 1. Prices are exclusive of 7% VAT and subject to change without prior notice.
2. Specifications may change without prior notice.

CEN-B



TISI 1379-2551

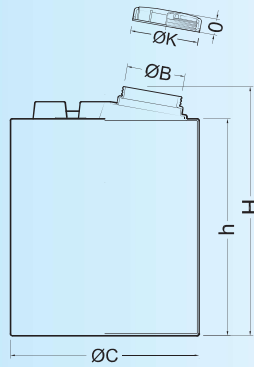

Tank						Lid				Approx. Total Weight (kg)	
Part Number	Capacity (Liters)	Approx. Dimensions (mm.)				Part Number	Approx. Dimensions (mm.)				
		B	C	H	h		Thk.	K	O	Thk.	
CEN050B-M114	50	150	380	550	480	3.5	CT0150B-HX29	150	40	2.0	3.18
CEN050B-M4X6						4.0					3.68
CEN050B-M115						5.0					4.18
CEN050B-M116						6.0					5.18
CEN100B-M5X6	100	150	500	660	575	3.5	CT0150B-HX29	150	40	2.0	4.68
CEN100B-M116						4.0					5.18
CEN100B-M118						5.5					7.18
CEN100B-M0X6						7.5					9.68
CEN200B-M118	200	150	650	750	670	3.5	CT0150B-HX29	150	40	2.0	7.18
CEN200B-M119						4.0					8.18
CEN200B-M123						6.0					12.18
CEN200B-M126						7.5					15.18
CEN300B-M122	300	150	650	1,050	970	4.0	CT0150B-HX29	150	40	2.0	11.18
CEN300B-M124						5.0					13.18
CEN300B-M126						5.5					15.18
CEN300B-M131						7.5					20.18
CEN500B-M127	500	395	870	1,040	915	4.5	CT0395A-M1X8	395	90	3.0	16.70
CEN500B-M129						5.0					18.70
CEN500B-M131						5.5					20.70
CEN500B-M138						7.5					27.70
CEN1K0B-M141	1,000	395	1,030	1,540	1,390	5.0	CT0395A-M1X8	395	90	3.0	30.70
CEN1K0B-M144						5.5					33.70
CEN1K0B-M156						7.5					45.70
CEN1K0B-M168						9.5					57.70
CEN1K0B-M171	10.0	60.70									
CEN1K5B-M154	1,500	395	1,300	1,430	1,280	5.5	CT0395A-M1X8	395	90	3.0	43.70
CEN1K5B-M158						6.0					47.70
CEN1K5B-M166						7.0					55.70
CEN1K5B-M180						10.0					79.70
CEN2K0B-M167	2,000	395	1,300	1,800	1,650	6.0	CT0395A-M1X8	395	90	3.0	56.70
CEN2K0B-M177						7.0					66.70
CEN2K0B-M186						8.0					75.70
CEN2K0B-M105						10.0					94.70
CEN2K5B-M173	2,500	395	1,300	2,050	1,900	6.0	CT0395A-M1X8	395	90	3.0	62.00
CEN2K5B-M184						7.0					73.00
CEN2K5B-M194						8.0					83.00
CEN2K5B-M211						10.0					100.00
CEN3K0B-M180	3,000	395	1,300	2,550	2,400	6.0	CT0395A-M1X8	395	90	3.0	69.00
CEN3K0B-M103						7.0					92.00
CEN3K0B-M216						8.0					105.00
CEN3K0B-M242						10.0					131.00

NOTE: 1. Prices are exclusive of 7% VAT and subject to change without prior notice.
2. Specifications may change without prior notice.

Sale : Ms Dung 0918077755

E: dung.nguyen@vietthaiqua.com

PHUOC INTERNATIONAL CO., LTD.

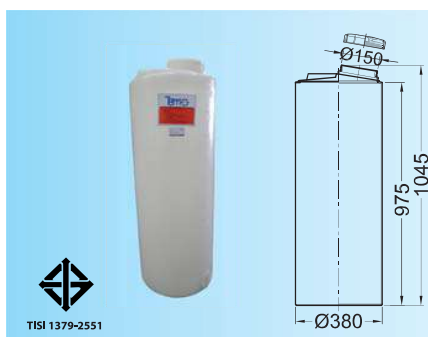

CEN100C

Tank			Lid		Approx. Total Weight (kg)
Part Number	Capacity (Litre)	Thk.	Part Number	Thk.	
CEN100C-M6X6	100	3.5	CT0150B-HX29	2.0	5.70
CEN100C-M117		4.0			6.20
CEN100C-M119		5.5			8.20
CEN100C-M122		7.5			10.90



CEN1K0C

Tank			Lid		Approx. Total Weight (kg)
Part Number	Capacity (Litre)	Thk.	Part Number	Thk.	
CEN1K0C-M141	1,000	5.0	CT0395A-M1X8	3.0	30.70



CEN2K0C

Tank			Lid		Approx. Total Weight (kg)
Part Number	Capacity (Litre)	Thk.	Part Number	Thk.	
CEN2K0C-M169	2,000	6	CT0395A-M1X8	3.0	58.00
CEN2K0C-M181		7			70.00
CEN2K0C-M191		8			80.00
CEN2K0C-M107		10			96.00

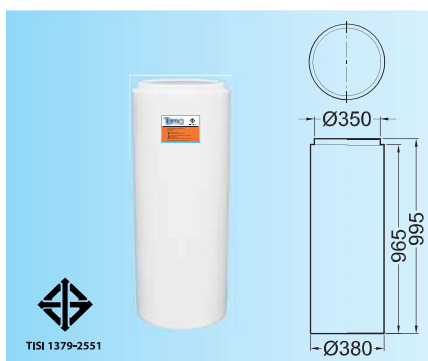

CON100C

Tank			Lid		Approx. Total Weight (kg)
Part Number	Capacity (Litre)	Thk.	Part Number	Thk.	
CON100C-M6X3	100	3.5	CN0350B-M1X6	2.0	5.70
CON100C-M6X9		4.0			6.20
CON100C-M8X9		5.5			8.20
CON100C-M122		7.0			10.90



CEN650E

Tank			Lid		Approx. Total Weight (kg)
Part Number	Capacity (Litre)	Thk.	Part Number	Thk.	
CEN650E-M132	650	4.5	CT0395A-M1X8	3.0	21.70

NOTE: 1. Prices are exclusive of 7% VAT and subject to change without prior notice.
2. Specifications may change without prior notice.

CEN25KE

Tank						Lid		Approx. Total Weight (kg)
Part Number	Capacity (Liters)	Approx. Dimensions (mm.)				Part Number	Thk.	
		B	C	H	h			Thk.
CEN25KE-M791	25,000	500	3,500	3,270	2,880	CT0500A-M2X9	3.0	681.8
CEN25KE-M891								781.8
CEN25KE-M981								871.8
CEN25KE-M081								971.8

CEN35KE

Tank						Lid		Approx. Total Weight (kg)
Part Number	Capacity (Liters)	Approx. Dimensions (mm.)				Part Number	Thk.	
		B	C	H	h			Thk.
CEN35KE-M2K6	35,000	500	3500	4,115	3,750	CT0500A-M2X9	3.0	954.50
CEN35KE-M2K9								1,094.50
CEN35KE-M3K1								1,220.50
CEN35KE-M3K3								1,360.50

CEN50KE

Tank						Lid		Approx. Total Weight (kg)
Part Number	Capacity (Liters)	Approx. Dimensions (mm.)				Part Number	Thk.	
		B	C	H	h			Thk.
CEN50KE-M3K5	*50,000	500	3,500	5,745	5,380	CT0500A-M2X9	3.0	1,363.60
CEN50KE-M3K8								1,562.00
CEN50KE-M4K1								1,743.60
CEN50KE-M4K5								1,943.60

NOTE: 1. Prices are exclusive of 7% VAT and subject to change without prior notice.
2. Specifications may change without prior notice.

CON-A



TISI 1379-2551

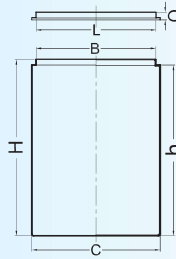

Part Number	Capacity (Litre)	Tank					Lid			Approx. Total Weight (kg)	
		Approx. Dimensions (mm.)					Approx. Dimensions (mm.)				
		B	C	H	h	Thk.	Part Number	K	O	Thk.	
CON050A-M114	50	340	380	520	490	4.0	CN0350B-M1X6	350	45	3.0	3.50
CON050A-M4X6						4.5					4.00
CON050A-M115						5.0					4.50
CON050A-M5X6						6.0					5.00
CON100A-M5X6						4.0					5.20
CON100A-M116	100	440	500	590	565	4.5	CN0435B-M1X8	435	45	3.0	5.70
CON100A-M7X6						5.5					7.20
CON100A-M119						7.0					8.70
CON200A-M118						4.0					8.40
CON200A-M8X6	200	595	650	680	660	4.5	CN0590B-M2X5	590	50	3.0	8.90
CON200A-M121						5.5					11.40
CON200A-M123						7.0					13.40
CON300A-M122						4.0					12.40
CON300A-M123	300	595	650	1,005	990	4.5	CN0590B-M2X5	590	50	3.0	13.40
CON300A-M126						5.5					16.40
CON300A-M120						7.0					20.40
CON500A-M127						5.0					17.80
CON500A-M120	500	780	870	920	875	6.0	CN0760B-M2X9	760	75	2.5	20.80
CON500A-M137						8.0					27.80
CON500A-M143						10.0					33.80
CON1K0A-M143						6.0					35.70
CON1K0A-M148	1,000	960	1,030	1,415	1,370	7.0	CN0940B-M4X8	940	95	3.0	40.70
CON1K0A-M154						8.0					46.70
CON1K0A-M164						10.0					56.70
CON1K5A-M152						6.0					46.80
CON1K5A-M158	1,500	1,230	1,300	1,300	1,260	7.0	CN1220B-M6X9	1,220	90	3.5	52.80
CON1K5A-M165						8.0					59.80
CON1K5A-M179						10.0					73.80
CON2K0A-M161						6.0					55.80
CON2K0A-M160	2,000	1,220	1,300	1,700	1,660	7.0	CN1220B-M6X9	1,220	90	3.5	64.80
CON2K0A-M178						8.0					72.80
CON2K0A-M195						10.0					89.80
CON2K5A-M167						6.0					61.80
CON2K5A-M177	2,500	1,200	1,300	1,940	1,900	7.0	CN1220B-M6X9	1,220	90	3.5	71.80
CON2K5A-M186						8.0					80.80
CON2K5A-M105						10.0					99.80
CON3K0A-M182						6.0					76.80
CON3K0A-M193	3,000	1,200	1,300	2,440	2,400	7.0	CN1220B-M6X9	1,220	90	3.5	87.80
CON3K0A-M205						8.0					99.80
CON3K0A-M228						10.0					122.80
CON4K0A-M221						8.0					121.00
CON4K0A-M241	4,000	1,500	1,600	2,210	2,160	10.0	CN1520E-M122	1,520	310	4.5	141.00
CON4K0A-M261						11.0					161.00
CON4K0A-M281						13.0					181.00
CON4K0A-M311						15.0					211.00
CON6K0A-M261	6,000	1,750	1,850	2,460	2,400	9.0	CN1750E-M126	1,750	345	4.5	165.00
CON6K0A-M291						11.0					195.00
CON6K0A-M331						13.0					135.00
CON6K0A-M361						15.0					165.00
CON10K0A-M371	10,000	2,000	2,100	3,240	3,320	11.0	-	-	-	-	260.00
CON10K0A-M421						13.0					310.00
CON10K0A-M471						15.0					360.00
CON10K0A-M521						17.0					410.00
CON10K0A-M541						18.0					430.00

NOTE: 1. Prices are exclusive of 7% VAT and subject to change without prior notice.
2. Specifications may change without prior notice.

Conical Bottom-Shaped Tank

CENA-E

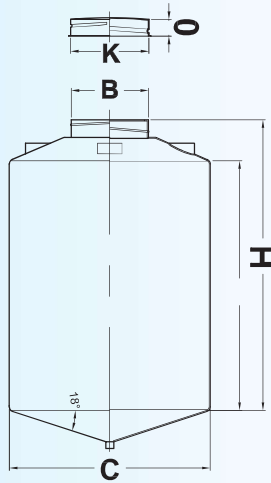
TISI 1379-2551

Part Number	Capacity (Liters)	Tank					Lid			Approx. Total Weight (kg)	
		Approx. Dimensions (mm.)					Approx. Dimensions (mm.)				
		B	C	H	h	Thk.	Part Number	K	O	Thk.	
CENA1K0E-M146	1,000	395	1,030	1,575	1,365	5.0	CT0395A-M1X8	395	90	3.0	35.00
CENA1K0E-M140						5.5					39.00
CENA1K0E-N163						7.5					57.00
CENA1K0E-M178						9.5					67.00
CENA1K5E-M162	1,500	395	1,300	1,530	1,280	5.5	CT0395A-M1X8	395	90	3.0	51.00
CENA1K5E-M167						6.0					56.00
CENA1K5E-N176						7.0					65.00
CENA1K5E-M104						10.0					93.00
CENA2K0E-M176	2,000	395	1,300	1,930	1,680	6.0	CT0395A-M1X8	395	90	3.0	63.00
CENA2K0E-M187						7.0					76.00
CENA2K0E-M198						8.0					87.00
CENA2K0E-M210						10.0					109.00
CENA2K5E-M181	2,500	395	1,300	2,150	1,900	6.0	CT0395A-M1X8	395	90	3.0	70.00
CENA2K5E-M193						7.0					82.00
CENA2K5E-M106						8.0					95.00
CENA2K5E-M229						10.0					118.00
CENA3K0E-M191	3,000	395	1,300	2,650	2,400	6.0	CT0395A-M1X8	395	90	3.0	80.70
CENA3K0E-M203						7.0					92.70
CENA3K0E-M216						8.0					105.70
CENA3K0E-M242						10.0					133.70
CENA4K0E-M247	4,000	500	1,600	2,450	2,150	8.0	CT0500A-M2X9	500	150	3.0	136.00
CENA4K0E-M281						10.0					170.00
CENA4K0E-M298						11.0					187.00
CENA4K0E-M332						13.0					221.00
CENA4K0E-M366	15.0	225.00									
CENA6K0E-M295	6,000	500	1,850	2,830	2,410	8.0	CT0500A-M2X9	500	150	3.0	184.00
CENA6K0E-M364						11.0					253.00
CENA6K0E-M300						13.0					299.00
CENA6K0E-M456						15.0					345.00
CENA10KE-M463	10,000	500	2,100	3,680	3,250	11.0	CT0500A-M2X9	500	150	3.0	352.00
CENA10KE-M527						13.0					416.00
CENA10KE-M591						15.0					416.00
CENA10KE-M655						17.0					480.00
CENA10KE-M687						18.0					576.00

NOTE: 1. Prices are exclusive of 7% VAT and subject to change without prior notice.
2. Specifications may change without prior notice.

Conical Bottom-Shaped Tank

CENB-E



TISI 1379-2551

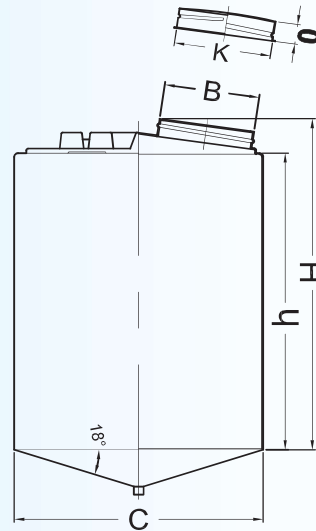

Part Number	Capacity (Liters)	Tank					Part Number	Lid			Approx. Total Weight (kg)
		Approx. Dimensions (mm.)						Approx. Dimensions (mm.)			
		B	C	H	h	Thk.	K	O	Thk.		
CENB100E-M116	100	150	500	660	575	3.5	CT0150B-HX29	150	40	2.0	5.0
CENB100E-M117						4.0					6.0
CENB100E-M118						6.0					7.5
CENB100E-M9X6						7.5					8.5
CENB200E-M120	200	150	650	750	670	3.5	CT0150B-HX29	150	40	2.0	10.0
CENB200E-M122						4.0					11.0
CENB200E-M128						6.0					16.0
CENB200E-M133						7.5					22.0
CENB500E-M131	500	395	870	1,040	915	4.5	CT0395A-M1X8	395	90	3.0	20.0
CENB500E-M133						5.0					22.0
CENB500E-M136						5.5					25.0
CENB500E-M145						7.5					34.0
CENB1K0E-M146	1,000	395	1,030	1,540	1,390	5.0	CT0395A-M1X8	395	90	3.0	35.0
CENB1K0E-M140						5.5					39.0
CENB1K0E-M163						7.5					57.0
CENB1K0E-M178						9.5					67.0
CENB1K5E-M162	1,500	395	1,300	1,430	1,280	10.0	CT0395A-M1X8	395	90	3.0	51.0
CENB1K5E-M167						5.5					56.0
CENB1K5E-M176						6.0					65.0
CENB1K5E-M104						7.0					93.0
CENB2K0E-M176	2,000	395	1,300	1,800	1,650	10.0	CT0395A-M1X8	395	90	3.0	63.0
CENB2K0E-M187						6.0					76.0
CENB2K0E-M198						7.0					87.0
CENB2K0E-M210						8.0					109.0
CENB2K5E-M181	2,500	395	1,300	2,050	1,900	10.0	CT0395A-M1X8	395	90	3.0	70.0
CENB2K5E-M193						6.0					82.0
CENB2K5E-M106						7.0					95.0
CENB2K5E-M229						8.0					118.0
CENB3K0E-M191	3,000	395	1,300	2,550	2,400	10.0	CT0395A-M1X8	395	90	3.0	80.7
CENB3K0E-M203						6.0					92.7
CENB3K0E-M216						7.0					105.7
CENB3K0E-M242						8.0					133.7

NOTE: 1. Prices are exclusive of 7% VAT and subject to change without prior notice.
2. Specifications may change without prior notice.

Conical Bottom-Shaped Tank

CONA-E



TISI 1379-2551

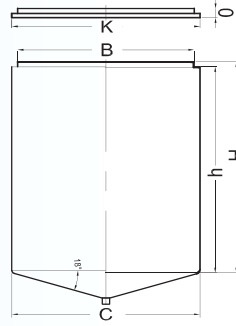

Tank						Lid				Approx. Total Weight (kg)	
Part Number	Capacity (Liters)	Approx. Dimensions (mm.)				Part Number	Approx. Dimensions (mm.)				
		B	C	H	h		Thk.	K	O		Thk.
CONA100E-M6X6	100	440	500	590	565	4.0	CN0435B-M1X8	590	50	3.0	9.5
CONA100E-M117						4.5					9.8
CONA100E-M8X6						5.5					12.5
CONA100E-M0X6						7.0					14.4
CONA200E - M9X2	200	595	650	680	660	4.0	CN0590B-M2X5	590	50	3.0	9.5
CONA200E - M9X5						4.5					9.8
CONA200E - M122						5.5					12.5
CONA200E - M124						7.0					14.4
CONA500E - M129	500	780	870	920	875	5.0	CN0760B-M2X9	760	75	2.5	19.3
CONA500E - M132						6.0					22.5
CONA050E - M138						8.0					29.1
CONA500E - M145						10.0					35.3
CONA1K0E - M130	1,000	960	1,030	1,415	1,370	6.0	CN0940B-M4X8	940	95	3.0	32.6
CONA1K0E - M145						7.0					37.2
CONA1K0E - M149						8.0					41.7
CONA1K0E - M159						10.0					51.2
CONA1K5E - M154	1,500	1,230	1,300	1,300	1,260	6.0	CN1220B-M6X9	1,220	90	3.5	48.5
CONA1K5E - M161						7.0					55.4
CONA1K5E - M168						8.0					62.3
CONA1K5E - M189						10.0					76.0
CONA2K0E - M164	2,000	1,220	1,300	1,660	1,700	6.0	CN1220B-M6X9	1,220	90	3.5	58.6
CONA2K0E - M172						7.0					67.1
CONA2K0E - M181						8.0					92.7
CONA2K0E - M198						10.0					75.7
CONA2K5E - M160	2,500	1,200	1,300	1,940	1,900	6.0	CN1220B-M6X9	1,220	90	3.5	64.7
CONA2K5E - M170						7.0					74.3
CONA2K5E - M189						8.0					83.7
CONA2K5E - M109						10.0					103.5
CONA3K0E - M184	3,000	1,200	1,300	2,440	2,400	6.0	CN1220B-M6X9	1,220	90	3.5	73.7
CONA3K0E - M196						7.0					85.7
CONA3K0E - M205						8.0					96.7
CONA3K0E - M231						10.0					120.7
CONA4K0E - M224	4,000	1,500	1,600	2,210	2,160	8.0	CN1520E-M122	1,520	310	4.5	126.0
CONA4K0E - M248						10.0					148.0
CONA4K0E - M263						11.0					163.0
CONA4K0E - M288						13.0					188.0
CONA4K0E - M396	6,000	1,750	1,850	2,400	2,460	15.0	CN1750E-M126	1,750	345	4.5	216.0
CONA6K0E - M279						9.0					175.0
CONA6K0E - M206						11.0					210.0
CONA6K0E - M349						13.0					245.0
CONA6K0E - M377	10,000	2,000	2,100	3,240	3,320	15.0	-	-	-	-	281.0
CONA10KE - M301						11.0					290.0
CONA10KE - M453						13.0					342.0
CONA10KE - M406						15.0					395.0
CONA10KE - M557	10,000	2,000	2,100	3,240	3,320	17.0	-	-	-	-	446.0
CONA10KE - M583						18.0					472.0

NOTE: 1. Prices are exclusive of 7% VAT and subject to change without prior notice.

2. Specifications may change without prior notice.

Sale : Ms Dung 0916077755

E: dung.nguyen@vietthaiaqua.com

PELCO INTERNATIONAL CO., LTD.

COT-A



TISI 1379-2551

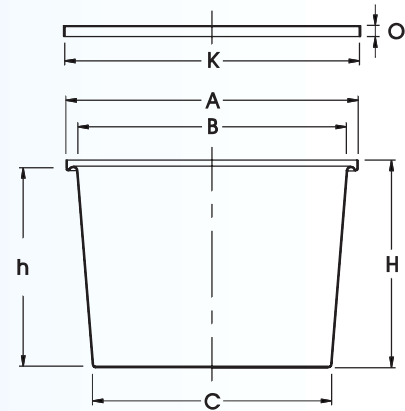

Part Number	Capacity (Litres)	Tank						Lid			Approx. Total Weight (kg)	
		Approx. Dimensions (mm.)						Approx. Dimensions (mm.)				
		A	B	C	H	h	Thk.	Part Number	K	O	Thk.	
COT040A-M113	40	520	420	330	360	335	3.5	-	-	-	-	2.0
COT040A-M3X3							4.0					2.2
COT150A-M6X6	150	700	650	570	610	580	4.0	-	-	-	-	5.5
COT150A-M7X6							4.5					6.5
COT150A-M9X6							6.0					8.5
COT150A-M122							7.5					11.0
COT200A-M118	200	760	700	560	730	705	4.0	CN0760A-M2X5	760	50	2.5	8.4
COT200A-M8X6							4.5					8.9
COT200A-M121							6.0					11.4
COT200A-M125							8.0					15.4
COT280A-M119	280	1,080	1,010	900	430	390	4.0	-	-	-	-	8.0
COT280A-M110							4.5					9.0
COT280A-M123							6.0					12.0
COT280A-M127							8.0					16.0
COT350A-M121	350	870	310	750	790	755	4.0	CN0870A-M3X4	870	45	3.0	12.3
COT350A-M122							4.5					13.3
COT350A-M125							6.0					16.3
COT350A-M120							8.0					21.3
COT500A-M128	500	1,100	1,020	900	780	740	5.5	CN1100A-M4X6	1,100	40	3.0	20.5
COT500A-M129							6.0					21.5
COT500A-M136							8.0					28.5
COT500A-M142							10.0					34.5
COT900A-M136	900	1,340	1,280	1,010	860	820	6.0	-	-	-	-	25.0
COT900A-M141							7.0					30.0
COT900A-M145							8.0					34.0
COT900A-M153							10.0					42.0
COT1K0A-M139	1,000	1,420	1,360	1,250	830	780	6.0	-	-	-	-	28.0
COT1K0A-M144							7.0					33.0
COT1K0A-M149							8.0					38.0
COT1K0A-M158							10.0					47.0
COT1K5A-M149	1,500	1,630	1,550	1,460	950	910	6.0	-	-	-	-	38.0
COT1K5A-M155							7.0					44.0
COT1K5A-M161							8.0					50.0
COT1K5A-M174							10.0					63.0

NOTE: 1. Prices are exclusive of 7% VAT and subject to change without prior notice.
2. Specifications may change without prior notice.

Intermediate Bulk Containers (IBC's)



The container has been developed for efficient and safe handling, storage and transportation of various products such as corrosive and non-corrosive chemicals, edible oils and other foodstuffs.

Special Features

- ✓ PE tanks with a 40 mm. integral-moulded level indicator (easy and accurate checking on liquid level)
- ✓ Fabrication with 1 -1/2" PVC recessed ball valves
- ✓ Special lining for the corrosive material
- ✓ Welded steel frame with hot-dip galvanized, epoxy painted or stainless steel 304
- ✓ Two-high stackable pallets permitting four-way entry by forklift truck and capable for overhead lifting
- ✓ Compliance with FDA regulation (177.1520)
- ✓ Performance and safety tested according to British standards

BTC

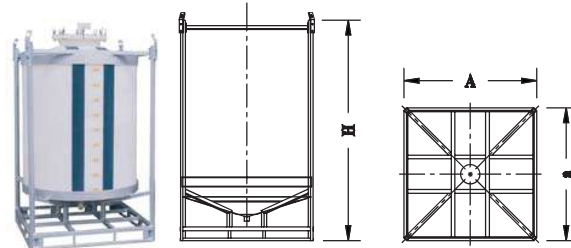

BTR

SR02

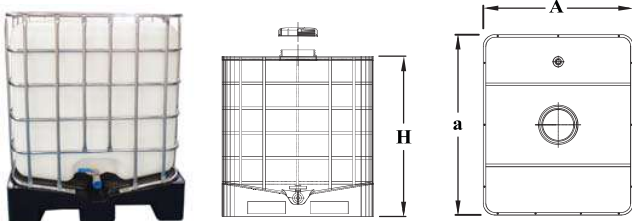

SR01

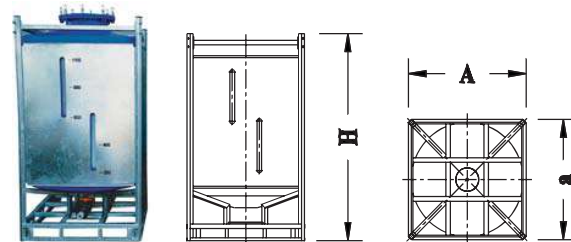

Part Number	Capacity (Litres)	App. Dimensions (mm)			PE Tank	PVC Ball Valve 1-1/2"	Frame
		A	a	H			
BTC1K0A-SR01	1,000	1,080	1,080	1,760	✓	✓	✓
BTC1K5A-SR01	1,500	1,350	1,350	2,060	✓	✓	✓
BTC2K0A-SR01	2,000	1,350	1,350	2,460	✓	✓	✓
BTC2K5A-SR01	2,500	1,350	1,350	2,680	✓	✓	✓
BTR1K0D-SR01	1,000	1,000	1,000	1,720	✓	✓	✓
BTR1K0D-SR02	1,090	1,310	1,000	1,165	✓	✓	✓



TISI 1379-2551

- NOTE:**
1. BTC and BTR tank models have minimum order qty as per frame's material.
 2. Prices are exclusive of 7% VAT and subject to change without prior notice.
 3. Specifications may change without prior notice.

Pharmaceutical Tank



TISI 1379-2551

REN-C

Tank								Lid				Approx. Total Weight (kg)	
Part Number	Capacity (Liters)	Approx. Dimensions (mm.)						Part Number	Approx. Dimensions (mm.)				
		A	B	a	H	h	Thk.		K	O	Thk.		
REN300C-M124	300	680	150	680	760	690	4.0	CT0150B-HX29	150	40	2.0	13.18	
REN300C-M127							5.0						22.18
REN300C-M120							6.0						
REN300C-M133							7.0						
REN1K0C-M155	1,000	1,050	395	930	1,180	1,100	6.5	CT0395A-M1X8	395	90	3.0	44.7	
REN1K0C-M162							7.5					51.7	
REN1K0C-M172							9.0					61.7	
REN1K0C-M185							11.0					74.7	



TISI 1379-2551

COT-D

Tank								Lid				Approx. Total Weight (kg)	
Part Number	Capacity (Liters)	Approx. Dimensions (mm.)						Part Number	Approx. Dimensions (mm.)				
		A	B	C	H	h	Thk.		K	O	Q		Thk.
COT300D-M118	300	820	760	640	830	805	3.0	CN0820C-M113	820	160	30	3.0	9.0
COT550D-M128	550	1,000	950	800	1,020	985	5.0	CN1000C-M114	1,000	235	40	3.0	20.0
COT1K0D-M137	1,000	1,210	1,130	930	1,240	1,205	5.5	CN1210C-M115	1,210	240	40	3.0	30.0
COT1K6D-M147	1,600	1,370	1,300	1,070	1,495	1,460	5.5	CN1370C-M117	1,370	240	40	3.5	42.0
COT2K0D-M157	2,000	1,480	1,410	1,170	1,610	1,575	6.0	CN1480C-M118	1,480	370	45	3.5	53.0
COT2K5D-M162	2,500	1,570	1,510	1,240	1,700	1,695	6.0	CN1570C-M110	1,570	370	45	3.5	60.0

NOTE: 1. Prices are exclusive of 7% VAT and subject to change without prior notice.
2. Specifications may change without prior notice.

Pharmaceutical Tank

COT-E

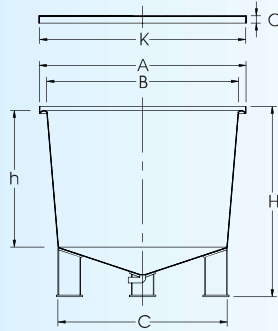

COT-F



TISI 1379-2551

Tank								Lid				
Part Number	Capacity (Liters)	Approx. Dimensions (mm.)						Part Number	Approx. Dimensions (mm.)			
		A	B	C	H	h	Thk.		K	O	Q	Thk.
COT200E-M122	200	760	700	560	960	710	4.0	CN0760A-M2X5	760	50	-	2.5
COT500E-M134	500	1,100	1,020	900	1,050	740	4.0	CN1100A-M4X6	1,100	40	-	3.0
COT200F-M122	200	760	700	560	960	710	4.0	CN0760A-M2X5	760	50	-	2.5
COT500F-M134	500	1,100	1,020	900	1,050	740	4.0	CN1100A-M4X6	1,100	40	-	3.0

CET-A

CET-B

CET-D

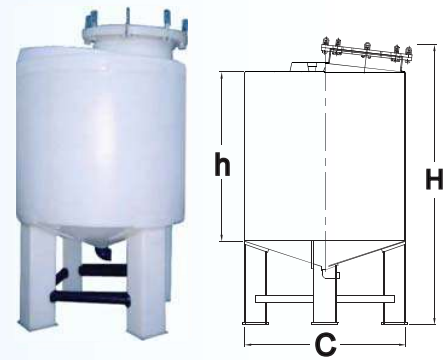
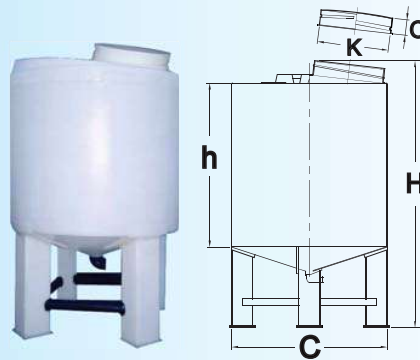
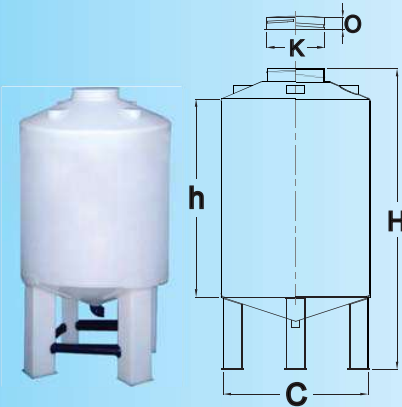

Tank								Lid				Approx. Total Weight (kg)	
Part Number	Capacity (Liters)	Approx. Dimensions (mm.)						Part Number	Approx. Dimensions (mm.)				
		A	B	C	H	h	Thk.		K	O	Q	Thk.	
CET200B-M125	200	-	-	560	1,010	710	5.0	CT0150B-HX29	150	40	-	2.0	14.18
CET500A-M145	500	-	-	900	1,220	740	5.0	CT0395A-M1X8	395	90	-	3.0	34.7
CET500B-M145	500	-	-	900	1,175	740	5.0						39.7
CET500B-M140		6.0	47.7										
CET500B-M158		7.5	51.0										
CET500D-M162	500	-	-	900	1,255	740	6.0	CT0395A-M1X8	395	90	-	3.0	51.0
CET500D-M160		7.5	59.0										

NOTE: 1. Prices are exclusive of 7% VAT and subject to change without prior notice.
2. Specifications may change without prior notice.

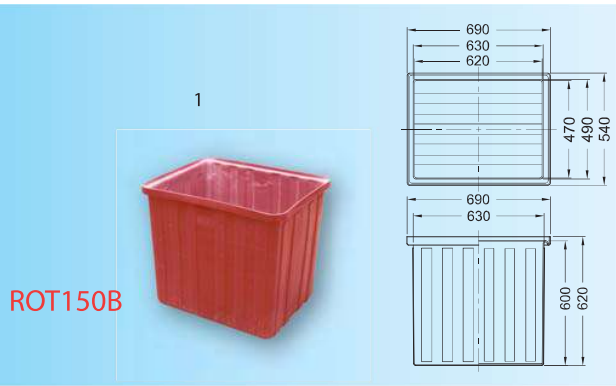

Tank		Lid		Approx. Total Weight (kg)
Part Number	Thk.	Part Number	Thk.	
ROT150B-M122	6.0	RN0690A-M2X6	3.0	12.5
ROT150B-M124	7.0	RN0690A-M2X6	3.0	14.5
ROT150B-M126	8.0	RN0690A-M2X6	3.0	16.5
ROT150B-M128	9.0	RN0690A-M2X6	3.0	18.5

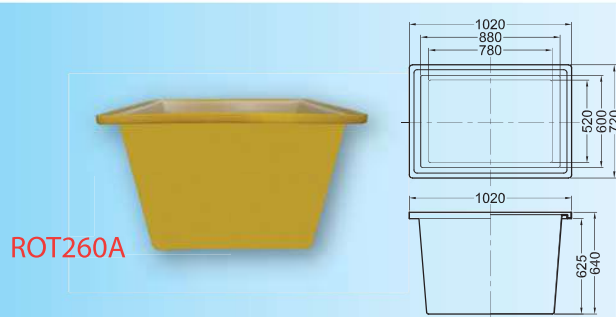

Tank		Lid		Approx. Total Weight (kg)
Part Number	Thk.	Part Number	Thk.	
ROT260A-M126	6.0	RN1020A-M4X5	3.5	18.4
ROT260A-M129	7.0	RN1020A-M4X5	3.5	21.4
ROT260A-M132	8.0	RN1020A-M4X5	3.5	24.4
ROT260A-M134	9.0	RN1020A-M4X5	3.5	26.4



**Tray Aerator
TM6070A-TA02N**

TM4014A-ZA01N

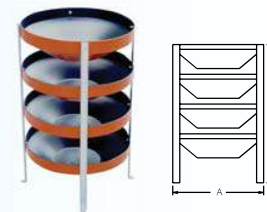

Part Number	Capacity (Litres)	Flow Capacity m³/h	No. of Tray	Filter Media pc/set	App. Dimensions (mm.)	
					A	H
TM4014A-ZA01N	14	1	4	100	485	730
TM6070A-TA02N	70	10	6	900	815	2,180

PE Biofiltration Media

120.00 THB /set
minimum order : 500 sets



20 pcs. PE plate

stand

- Used for filtration application in pressured sand filter, carbon filter, softener tanks, etc. These nozzles are installed on strainer plate design and header lateral system for distribution and collection purpose.











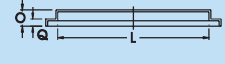

4.00 THB /pc.
minimum order : 5,000 pcs.

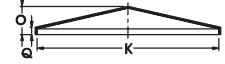
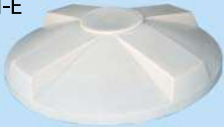
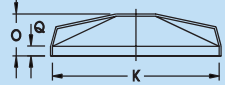

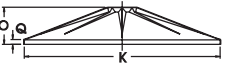
- Lightweight construction
- Serves as the attachment basis for microorganisms
The spacing serves as the passage of water to provide enough room for bacterial growth
- Widely used in sanitary sewage and industrial water processing

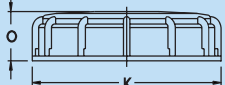
NOTE: 1. Prices are exclusive of 7% VAT and subject to change without prior notice.
2. Specifications may change without prior notice.

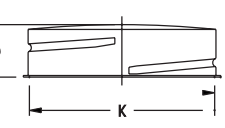
PE Tank Lid

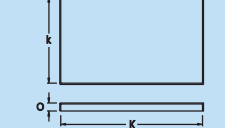
Type	Part Number	Approx. Dimension (mm.)						Approx. Weight (kg)
		K	L	k	O	Q	Thk.	
CN-A  	CN0760A-M2X5	760			50		2.50	1.4
	CN0870A-M3X4	870			45		3.00	2.30
	CN1100A-M4X6	1,100			40		3.00	3.50
	CN1100A-M7X6	1,100			40		5.00	6.50
CN-B  	CN0435B-M1X8		435		45	25	3.00	0.70
	CN0590B-M2X5		590		50	25	3.00	1.40
	CN0760B-M2X9		760		75	30	2.50	1.80
	CN0760B-M9X7		760		75	30	7.00	8.60
	CN0940B-M4X8		940		95	45	3.00	3.70
	CN1220B-M6X9		1,220		90	45	3.50	5.80
CN-C  	CN0820C-M113	820			160	30	3.00	2.00
	CN1000C-M114	1,000			235	40	3.00	3.00
	CN1100C-M115	1,100			190	40	3.00	4.00
	CN1210C-M115	1,210			240	40	3.00	4.00
	CN1370C-M117	1,370			240	40	3.50	6.00
	CN1480C-M118	1,480			370	45	3.50	7.00
	CN-E	CN0940E-M4X8	940			210	50	3.00
CN-E  	CN1220E-M6X9	1,220			235	50	3.50	5.80
	CN1520E-M122	1,520			310	65	4.50	11.00
	CN1750E-M126	1,750			345	75	4.50	15.00
CN-S  	CN0985S-M114	985			195	55	3.00	3.00
	CN1100S-M4X6	1,100			195	55	3.00	3.50
	CN1250S-M116	1,250			245	55	5.00	5.00
CT-B  	CT0150B-HX29	150			40		2.00	0.18
	CT-A	CT0395A-M1X8	395			90		3.00
CT-A  	CT0500A-M2X9	500			150		3.00	1.80
	RN-A  	RN0690A-M2X6	690		540	30		3.00
RN1020A-M4X5		1,020		720	30		3.50	3.40

NOTE: 1. Prices are exclusive of 7% VAT and subject to change without prior notice.
2. Specifications may change without prior notice.

Fittings and Accessories



Plastic Welding Gun & Rods



Fittings



Air Vent

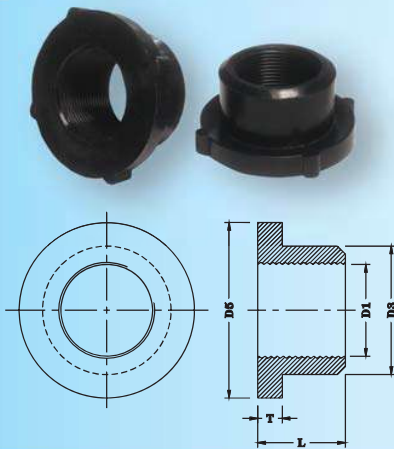

NPT Female Straight

Part Number	Nominal Size		Approx. Dimension (mm.)					Approx. Total Weight (kg)
	mm.	Inch	D1	D3	D5	L	T	
FAM015A	15	1/2	19.6	30	45	26	8	17.5
FAM020A	20	3/4	26	42	55	35	10	32.0
FAM025A	25	1	31.6	46	75	40	12	58.0
FAM040A	40	1-1/2	45	63	86	43	12	82.5
FAM050A	50	2	57	74	95	48	15	108.0
FAM065A	65	2-1/2	71.6	88	95	50	15	152.5
FAM080A	80	3	84	103	109	53	15	152.5
FAM100A	100	4	110	130	144	75	18	307.5
FAM150A	150	6	165	185	195	80	20	-
FAM200A	200	8	215	240	250	80	25	-
FAM250A	250	10	270	300	310	85	30	-

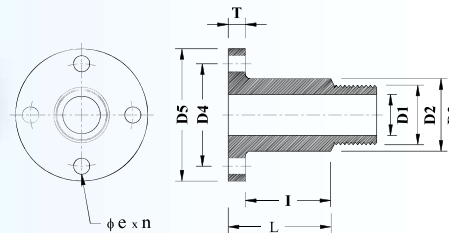

Flanges, JIS 10k (Also available in other standards ie. ANSI, DIN)

Part Number	Nominal Size		Approx. Dimension (mm.)														Approx Total Weight (kg)	
	mm.	Inch	D1	D2	D3	D4	D5	L	I	øe	D4	D5	L	I	T	øe		n
GAM015A-X	15	1/2	14	19.5	30	70	95	95	80	15	60	89	142	97	15	16	4	0.15
GAM020A-X	20	3/4	18	26.5	35	75	100	95	80	15	70	98	145	95	15	16	4	0.15
GAM025A-X	25	1	25	33.5	42	90	125	95	80	19	79	108	153	93	15	16	4	0.25
GAM040A-X	40	1-1/2	35	47	53	105	140	95	78	19	98	127	160	93	17	16	4	0.35
GAM050A-X	50	2	45	58.5	65	120	155	95	75	19	121	152	160	90	20	19	4	0.45
GAM065A-X	65	2-1/2	60	75	85	140	175	85	65	19	140	178	165	85	20	19	4	0.70
GAM080A-X	80	3	70	86	95	150	185	85	65	19	152	191	165	85	20	19	8	0.70
GAM100A-X	100	4	90	112	120	175	210	80	57	19	191	229	180	82	23	19	8	1.05
GAM150A-X	150	6	150	167	180	240	280	100	75	23	241	279	200	100	25	23	8	1.95
GAM200A-X	200	8	195	217	230	290	330	100	70	23	298	343	210	100	30	22	12	2.95
GAM250A-X	250	10	250	272	300	355	400	100	70	25	362	406	215	100	30	25	12	-

NOTE: 1. Prices are exclusive of 7% VAT and subject to change without prior notice.
2. Specifications may change without prior notice.