

Sale : Ms Dung 0918077755

SIMPLE
AS WATER

E: dung.nguyen@vietthaiqua.com

Pools Catalogue

emec 



Sale : Ms Dung 0918077755

E: dung.nguyen@vietthaiqua.com

Sale : Ms Dung 0918077755

E: dung.nguyen@vietthaiqua.com

SIMPLE
AS WATER

Pool Catalogue
2022

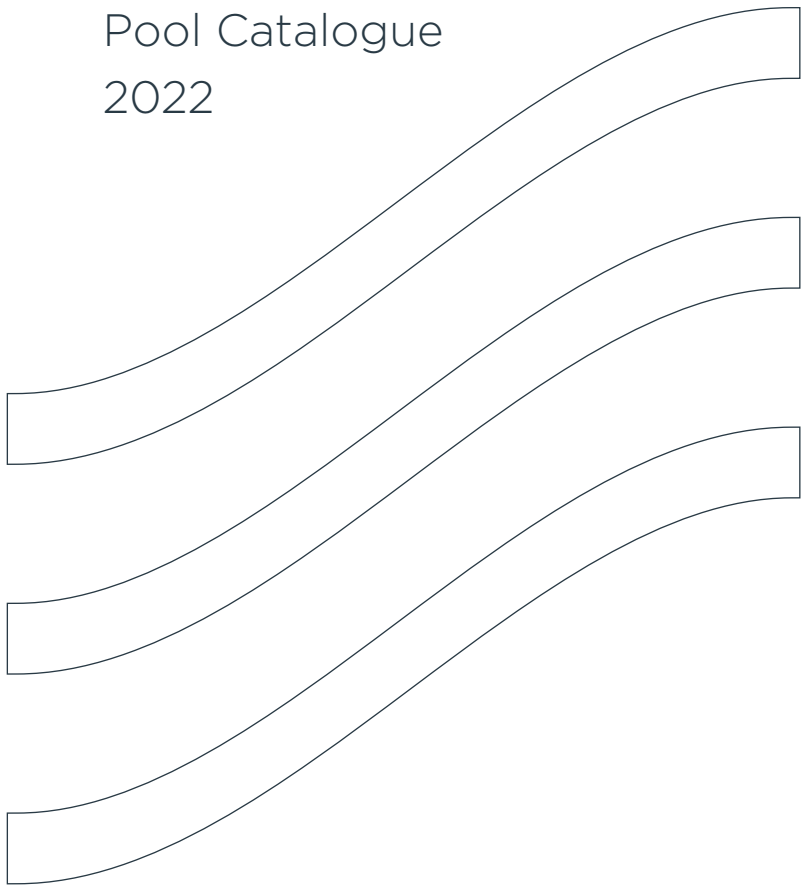

Sale : Ms Dung 0918077755

E: dung.nguyen@vietthaiqua.com



EMEC

SYSTEMS FOR SWIMMING POOLS

Flexibility and innovation

Flexibility and innovation are fundamental to us. Since 1982, we have been designing and producing reliable, cutting-edge instruments for water treatment and chemicals dosing. As a company, we are open to change and, just like water, we have branched out over time, spreading out into wide-ranging areas, from industrial water treatment to potabilization to water purification, from food and beverage industry to swimming pools.

OUR VALUE

Being at the cutting edge means constant study. Our R&D and design departments are where our heart beats. Extremely high-profile engineers and technicians are committed to developing software and designing hardware, but also to studying and evaluating hydraulic and mechanical components. The customers and their satisfaction have always been at the heart of what we do, so we pay constant attention to the quality of our production processes, through a constantly updated and cutting-edge range of industrial machines.

QUALITY AND SAFETY, FIRST OF ALL

We are entirely responsible for every stage of the process, from invention to delivery. Our products undergo up to 10 quality checks and are tested four times before reaching the customer. The quality management system of our production process is ISO 9001 certified and has customer satisfaction as its ultimate goal, as well as continuous improvement of company performance.

Customers satisfaction comes hand-in-hand with ensuring safety for them, their operators and final users. Our dosing pumps and controllers are UL certified to guarantee full compliance with general requirements for safety of use, while **NSF** certifications guarantee that our pumps do not release hazardous pollutants into the water and therefore are fully safe for use in contact with drinking water, for example in the food production industry, or at recreational facilities like swimming pools and spas.

COMPETENCE AND PROFESSIONALISM

Extremely high performance, top quality and high

technology are our greatest assets. But there is more. Every day, we safeguard something equally important: human capital. Our co-workers are the best professionals on the market; the most expert and competent people.

For this reason our organizational model is designed to manage their safety and health in an organic and systematic way, respecting the international standard **BS OHSAS 18001**.

ENVIRONMENTAL SUSTAINABILITY

The adoption of an environmental management system compliant with the international standard **ISO 14001** arises from the awareness of the imprint that human activities leave on the planet. Our environmental protection management system allows us to minimize the impact of production processes (with emissions well below the prescribed limits), of products and of raw materials used (with the recycling of most of the waste materials), also thanks to an energy saving system that covers all company spaces and to the use of renewable energy sources.



100% MADE IN ITALY
All our products are 100% Made in Italy.



WARRANTY
5 years warranty for our dosing pumps and controllers.



Certified to NSF/ANSI/CAN 50



POOL CATALOGUE

Smart systems

POOLBRAVO

6/7

Dosing pumps

MULTIFUNCTIONS MODE DOSING PUMPS

Flow control

8/11

CONSTANT MODE DOSING PUMPS

Flow control

12/15

PROPORTIONAL DOSING PUMPS WITH PARAMETER MEASUREMENT

PH / ORP measurement & control

16/17

DOSING PUMPS

Anti algae, active oxygen, flocculant measurement and control

27/29

DOSING PUMPS

Scent and essences dosing for health spa

30/31

DOSING PUMPS

Foot-bath disinfection systems

32/33

DOSING PUMPS

Dechloration system for filters cleaning waters

34/35

All-in-one dosing pumps

ALL-IN-ONE DOSING PUMPS

WDPHXX series, also available with peristaltic pumps

18/19

ALL-IN-ONE DOSING PUMPS

Multiparameter measurement and control

20/23

ALL-IN-ONE DOSING PUMPS

*Dry feeder and salt chlorine generator measurement and control
Bromine, pH and active oxygen measurement and control*

24/26



Digital controllers

SINGLE PARAMETER DIGITAL CONTROLLERS

*pH - ORP - Cl₂ - Br₂ - O₃ - Total Chlorine - H₂O₂ - Inductive conductivity
- Turbidity + Temperature measurement and control*

36/39

MULTIPARAMETER DIGITAL CONTROLLERS

Measurement and control of several parameters simultaneously

40/43

Remote measurement and control

ERMES

44/45

MODEM AND EXTERNAL MODULES FOR COMMUNICATION

For LD, WDPHXX and CENTURIO controller series

--/49

All-in-one control and dosing solutions

ALL-IN-ONE SYSTEMS

50/53

ALL-IN-ONE SYSTEMS

Digital system with open amperometric cell ECL6

54/55

ALL-IN-ONE SYSTEMS

Digital system with closed amperometric cell SCL3S/20 and PEF1

56/57

ADVANCED ALL-IN-ONE SYSTEMS

58/61

Accessories

LIST OF COMPATIBLE ACCESSORIES

62/65

Sale : Ms Dung 0918077755

E: dung.nguyen@vietthaiqua.com

SWIMMING POOL MADE SMART



 POOLBRAVO

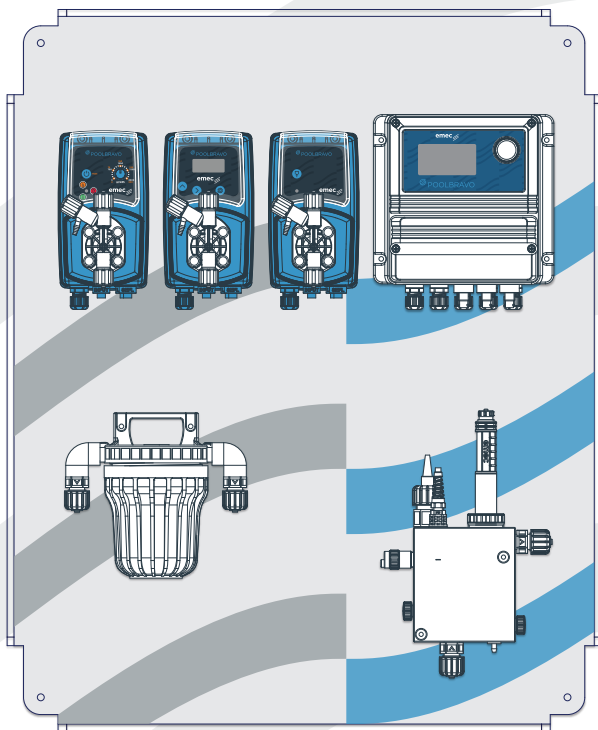

A multi-colored LED light is installed on PEF probe-holder in order to quickly signal, through an opening on the cover, specific operation statuses or possible alarms according to the color of the light.

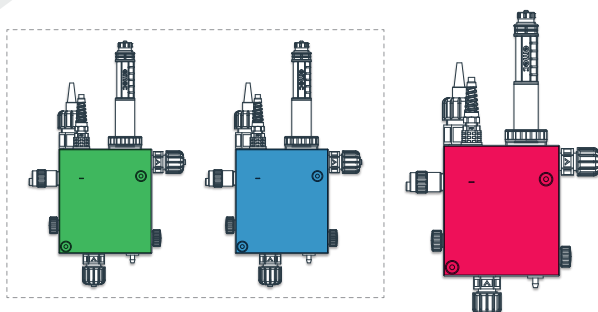

GREEN or **BLUE** (depending on the version) means the device is correctly functioning.

RED means the device is in an alarm status.

POOLBRAVO

The POOLBRAVO integrated system has been designed to offer an all-in-one solution that is easy to use and highly accurate, able to minimize the need for manual intervention on swimming pool water and to reduce the consumption of chemical products. An elegant cover makes POOL BRAVO suitable for any installation context and, besides safeguarding from accidental liquid loss, preserves at the same time the cleanliness of the inner components and their integrity.

POOLBRAVO is a turnkey product available in different configurations to immediately and easily manage the main measurement parameters concerning the treatment of swimming pool water, thus optimizing the dosing and consumption of the chemical products necessary for the compliance with chemical-physical water requirements.

COMPLETE CONTROL

The LD multiple reading digital system inside POOLBRAVO gives you the complete control over the measurement parameters and over the dosing of chemicals, besides being easy to use thanks to the LCD display and the ENCODER control knob that makes simple to browse through its configuration menus. Complete control also comes from the wide range of probes that can measure hydrogen peroxide, oxygen, bromine, chlorine, ozone, peracetic acid and chlorine dioxide. EMEC V series dosing pumps complete POOL BRAVO dosing system.

REMOTE CONTROL

EMEC exclusive online system ERMES enables you to remotely control and regulate POOLBRAVO from any smartphone or PC, so to keep the status of your swimming pool always under control, wherever you are.

Multifunctions mode dosing pumps

Flow control

(Constant, Divide, Multiply, PPM, Batch, Volt, mA, %, ml/q), stand-by* and flow sensor input*, alarm output** and level control.

AMS MF



PRESSURE

7 bar
3 bar
2 bar

FLOW

20 l/h
40 l/h
60 l/h



KMS MF



PRESSURE

2 bar
5 bar
20 bar

FLOW

18 l/h
10 l/h
1 l/h

Multifunctions mode dosing pumps

Flow control

(Constant, Divide, Multiply, PPM, Batch, Volt, mA, %, ml/q), stand-by* and flow sensor input*, alarm output** and level control.

TMS MF



PRESSURE

4 bar
3 bar
1 bar

FLOW

20 l/h
30 l/h
50 l/h



VMS MF



PRESSURE

5 bar
10 bar
3 bar
2 bar

FLOW

1 l/h
4 l/h
10 l/h
15 l/h

*Non disponibile su mod. VMS MF

**Uscita allarme livello opzionale su mod. VMS MF e mod. VCL

Constant mode dosing pumps

Flow control

Constant mode dosing pumps with level and flow control. Double frequency scale.

AMS CL PLUS



PRESSURE

7 bar
3 bar
2 bar

FLOW

20 l/h
40 l/h
60 l/h



K CL PLUS



PRESSURE

2 bar
5 bar
20 bar

FLOW

18 l/h
10 l/h
1 l/h

Constant mode dosing pumps

Flow control

Constant mode dosing pumps with level and flow control. Double frequency scale.

T CL



PRESSURE

4 bar
3 bar
1 bar

FLOW

20 l/h
30 l/h
50 l/h



V CL



PRESSURE

5 bar
10 bar
3 bar
2 bar

FLOW

1 l/h
4 l/h
10 l/h
15 l/h

Proportional dosing pumps with parameter measurement

PH / ORP measurement & control

Proportional dosing pumps with pH and/or ORP measurement and control, with overdose alarm.

TMS PH & TMS RH



TMS PH

Proportional pump driven by internal built-in pH meter (0÷14pH) stand-by and level control, supplied without pH probe.

TMS RH

Proportional pump driven by internal built-in ORP meter (0÷1000mV) stand-by and level control, supplied without ORP probe.

PRESSURE

4 bar
3 bar
1 bar

FLOW

20 l/h
30 l/h
50 l/h



VMS PO



VMS PO

Proportional pump driven by internal built-in pH meter (0/14pH) or ORP meter (-1000mV/+1000mV). Parameter set by menu. Level control. PVDF pump head and accessories. Fast calibration on standard value. Restore last calibration.

PRESSURE

5 bar
10 bar
3 bar
2 bar

FLOW

1 l/h
4 l/h
10 l/h
15 l/h

Sale : Ms Dung 0918077755

E: dung.nguyen@vietthaiqua.com

PERISTALTIC WD: PRECISE, RELIABLE, NOISELESS



 WD

All-in-one dosing pumps

WDPHXX series, also available with **peristaltic pumps**

18/19



WDPHXX / WDPHXX PER

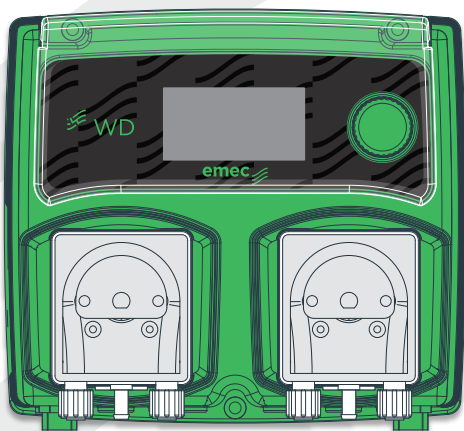

Standard WDPHXX PER pump

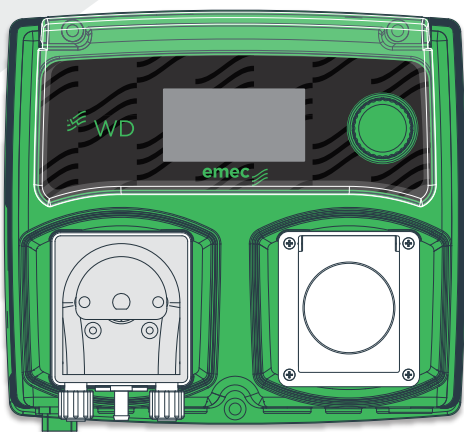

WDPHXX PER pump with output
(230 VAC / 10A) for sterilisers or Cl/
Br feeders

WDPHxx series has been created by EMEC to provide a complete and small-sized solution for swimming pool water treatment. WDPHXX systems are all-in-one, compact instruments which integrate two dosing pumps and a control instrument into a single, easy to use, highly precise system.

WDPHXX systems can measure pH and another parameter that depends on the chosen model: chlorine, bromine, Redox, antialgae, flocculant, active oxygen. A wide range of products for the highest flexibility.

WDPHXX PER: RELIABLE AND NOISELESS

WDPHXX proportional dosing systems in the versions with peristaltic dosing pumps (WDPHXX PER) are the best solution to be installed where silent operation and high reliability are required, like in spa and wellness facilities.

The integrated peristaltic pumps are indeed the most suitable for micro-dosing needs with lower pressure, ensuring at the same time an absolutely constant and accurate flow rate. Moreover, peristaltic pumps promise to have low power consumption thanks to low voltage.

COMPLETE CONTROL, EVEN REMOTELY

A clear reading of data and an easy browsing through function menus are made simple by a wide backlit LCD display and by the "Encoder" control knob, in order to quickly program the working modes you need, to set alarms and to manage outputs.

You can also remotely control WDPHXX systems from any smartphone or PC with EMEC exclusive online system ERMES, so to keep the status of your plant always under control wherever you are.

All-in-one dosing pumps

Multiparameter measurement and control

WDPHCL

pH & Chlorine



WDPHCL / WDPHCL PER

Swimming pool controller with 2 dosing pumps for acid (pH) and chlorine (Cl₂). Liquid ends and pump head made of PVDF.

Also available with peristaltic pumps (WDPHCL PER).

Wheel control system

Alarm output

RS485 output

Measurement range:
from 0 to 14 pH
from 0 to 10 mg/l Cl₂

PRESSURE

5 bar

3 bar

1 bar

FLOW

1 l/h

10 l/h

3 l/h



WDPHRH

pH & ORP



WDPHRH / WDPHRH PER

Swimming pool controller, 2 dosing pumps for acid (pH) and disinfectant (ORP).
Liquid ends and pump head made of PVDF.

Also available with peristaltic pumps (WDPHRH PER).

Wheel control system

Alarm output
RS485 output

Measurement range:
from 0 to 14 pH
from 0 to 1000 mV

PRESSURE

5 bar
3 bar
1 bar

FLOW

1 l/h
5 l/h
3 l/h

All-in-one dosing pumps

Multiparameter measurement and control

WDPHCLS

pH and Chlorine/Bromine



WDPHCLS / WDPHCLS PER

Proportional controller with 1 dosing pump driven by internal built-in pH and Chlorine/Bromine meter. Output: (SCHUKO plug) for sterilisers or Cl/Br feeders. Liquid ends and pump head made of PVDF.

Also available with peristaltic pumps (WDPHCLS PER).

Measurement range:
from 0 to 14 pH
from 0 to 10 mg/l Cl₂ / Br₂

Option: free of voltage EV contact.

PRESSURE

5 bar
3 bar
1 bar

FLOW

1 l/h
10 l/h
3 l/h

EV OUTPUT

230 VAC

MAX LOAD

10 A



WDPHRHS

pH and ORP



WDPHRHS / WDPHRHS PER

Proportional controller with 1 dosing pump driven by internal built-in pH and ORP meter. Output: (SCHUKO plug) for sterilisers or Cl/Br feeders. Liquid ends and pump head made of PVDF.

Also available with peristaltic pumps (WDPHRHS PER).

Measurement range:
from 0 to 14 pH
from 0 to 1000 mV

Option: free of voltage EV contact.

PRESSURE

5 bar
3 bar
1 bar

FLOW

1 l/h
10 l/h
3 l/h

EV OUTPUT

230 VAC

MAX LOAD

10 A

All-in-one dosing pumps

*Dry feeder and salt chlorine generator measurement and control
Bromine, pH and active oxygen measurement and control*

WDPHCA



WDPHCA / WDPHCA PER

Proportional controller with 2 dosing pumps for pH and anti algae. 230VAC EV proportional or on/off output for Cl/Br feeders.

Weekly anti algae timer and level probe.

Liquid ends and pump head made of PVDF.

Also available with peristaltic pumps (WDPHCA PER).

Wheel control system

Alarm output

RS485 output

Measurement range:
from 0 to 14 pH
from 0 to 10 mg/l Cl₂

PRESSURE

3 bar

1 bar

FLOW

10 l/h

3 l/h

Optional: free of voltage EV contact.



WDPHCF



WDPHCF / WDPHCF PER

Proportional controller with 2 dosing pumps for pH (acid- base) and flocculant. 230VAC EV proportional or on/off output for Cl/Br feeders. Level probe and gr/day flocculant dosing. Liquid ends and pump head made of PVDF.

Also available with peristaltic pumps (WDPHCF PER).

Wheel control system

Alarm output

RS485 output

Measurement range:
from 0 to 14 pH
from 0 to 10 mg/l Cl₂

Optional: free of voltage EV contact.

PRESSURE

3 bar

1 bar

FLOW

10 l/h
(sezione pH)

3 l/h

All-in-one dosing pumps

*Dry feeder and salt chlorine generator measurement and control
Bromine, pH and active oxygen measurement and control*

WDPHOS



WDPHOS & WDPHOS PER

Proportional controller with 2 dosing pumps for pH (acid- base) and active oxygen. Level probe. Temperature reading with enclosed probe. Weekly or daily (hr) active oxygen dosing. Liquid ends and pump head made of PVDF.

Also available with peristaltic pumps (WDPHCA PER).

Settings:

- daily or weekly timer
- temperature compensation - pool size

Wheel control system Alarm output

RS485 output

PH measurement range: from 0 to 14

Optional: free of voltage EV contact.

PRESSURE

3 bar
3 bar
1 bar

FLOW

10 I/h (for pH)
4 I/h (for active oxygen)
3 I/h

Dosing pumps

Anti algae, active oxygen, flocculant measurement and control

26/27



VMS EN

Anti algae



VMS EN

Anti algae pump with weekly timer for shock type water treatment. Quantities adjustable in cc units.

Level probe included.

PRESSURE

3 bar

FLOW

10 l/h

Dosing pumps

Anti algae, active oxygen, flocculant measurement and control

VM5A H₂O₂

Active oxygen



VM5A H₂O₂

Active oxygen pump.

Also available with peristaltic pump (VM5A H₂O₂ PER).

Settings:

- day/week timer
- temperature compensation
- pool size

Level and temperature probes included.

PRESSURE

3 bar

2 bar

FLOW

4 l/h

10 l/h



VCOG & VCLG

Flocculant



VCOG & VCLG

Metering pump for flocculant.

Double scale (24h):

- 0 to 300 gr/day

- 0 to 3000 gr/day

Level probe included.

PRESSURE

5 bar

FLOW

3000 gr/24h

Dosing pumps

Scent and essences dosing for spa

VCLS

Scent and essences dosing



VCLS

Silenced pump for scent and essences dosing at spas and hammam centres.

Double scale:

- 0 to 100 g/hr

- 0 to 1000 g/hr

Level probe included.

PRESSURE

7 bar

FLOW

1 l/h



VCLSE

C.E. Scent and essences dosing



VCLSE

Silenced pump for scent and essences dosing at spas and hammam centres. Contact (N.O.) for external control.

Double scale:

- 0 to 100 g/hr
- 0 to 1000 g/hr

Level probe included.

PRESSURE

7 bar

FLOW

1 l/h

Dosing pumps

Foot-bath disinfection systems

VMS MF + CTFI



VMS MF + CTFI

Foot-bath disinfection system.

It works with a pulsar sender water meter (1/2" size).

% control with level probe.

PRESSURE

5 bar

FLOW

12 l/h

CTFI

1/2"



TMS MF + CTFI



TMS MF + CTFI

Foot-bath disinfection system.

It works with a pulsar sender water meter (1/2" size).

% control with level probe.

PRESSURE

3 bar

FLOW

30 l/h

CTFI

1/2"

Dosing pumps

Dechloration system for filters cleaning waters

VCLD



VCLD

Dechlorination system for waters filters (chlorine).
Level meter. SEFT C contact less water sensor
(fittings 3/4").
SEFT P flow sensor (fittings 1/2").

Settings:

- 0-800 gr/h
- 0-8000 gr/h

Level probe included.

SEFT C and SEFT P are optional.

PRESSURE

3 bar

FLOW

10 l/h



VMS MF + CTFI & CWFA



VMS MF + CTFI & CWFA

Dechloration system for water filters.

It works with a pulse sender water meter (1.1/2" or 2" size).

Proportional volume control (product ppm) with level meter.

PRESSURE

3 bar
2 bar

FLOW

10 l/h
15 l/h

CTFI

1"1/2 e 2"

CWFA

3" e 4"

Single parameter digital controllers

pH - ORP - Cl2 - Br2 - O3 - Total Chlorine - H2O2 - Inductive conductivity - Turbidity + Temperature measurement and control

LDS series



LDS / LDS PLUS

Options:

- USB for data log recording
- Current Output (0/4 - 20 mA)
- Ethernet
- 3G/4G modem
- MODBUS
- WIFI

LDS PLUS features

- 5 relais (2 setpoint; alarm; probe cleaning; circulation)
- Probe Cleaning
- PID
- mA output



MODELS

LDSPH / LDSPH PLUS

pH measurement and control

LDSRH / LDSRH PLUS

ORP measurement and control

LDSCCL / LDSCCL PLUS

Chlorine measurement and control (reading scale based on probe)

LDSCD / LDSCD PLUS

Conductivity measurement and control

LDSCDIND / LDSCDIND PLUS

Inductive conductivity measurement and control (ECDINDPT probe)

LDSETORB2 / LDSETORB2 PLUS

Turbidity measurement and control (ETORB2 probe)

LDSTRC / LDSTRC PLUS

Florescence measurement and control

LDSFL / LDSFL PLUS

Fluorine measurement and control

Wheel with "EASY-NAV" control, flow control, local & Remote Control,ERMES web communication, permanent data storage with system log, PT100 temperature probe, Stand-by input, Alarms: damaged probes - max dosage - threshold - levels - flow, Programmable delay at dosing start-up (up to 60 minutes), Priority dosage, Automatic temperature compensation, Probe readout menu (LDSCDIND), Working modes: on/off, impulsive proportional, proportional PWM and fixed PWM, Automatic or manual dosing activity, mA output (option).



Single parameter digital controllers

RACK MOUNTING CONTROLLERS

Controller for: pH, ORP, Chlorine (Total chlorine, Free Chlorine, Chlorine Dioxide, Hydrogen Peroxyde, Ozone, Bromine, Peracetic Acid depending on the probe), Conductivity (Probes not included). 2 On-Off/proportional setpoints, Flow alarm, Flow sensor stand-by input, 0÷20 mA or 4÷20 mA output proportional to read measured value and programmable in the reading range.

JA PRO



JA PRO control instruments are rack mounting (96x96) single reading systems with temperature reading. On/Off, impulsive proportional and PID are main working modes.

It can set and monitor: pH, ORP, chlorine (depending on the probe: total chlorine, free chlorine, chlorine dioxide, hydrogen peroxide, ozone, bromine or paracetic acid) and conductivity ($\mu\text{S/S}$ - Ohm - TDS / PPM) with automatic range and probe / product selection (H₃PO₄ - H₂SO₄ - HNO₃ - HCl - NaOH - NaCl). Probes are not included.

JA PRO has: 2 setpoints (on/off, proportional), flow alarm, flow sensor stand-by input, 0-20 mA or 4-20 mA output proportional to read value and programmable in the reading range, alarm output. Available low voltage 12VDC or 24VDC power supply. Available IP54 protection cover.

JA PRO is equipped with mA module and MODBUS serial communication to be connected to other devices on RS485 networks and TCP/IP MODBUS.

JA PRO

Options:

- 12VDC or 24VDC power supply
- IP54 protection

JA PRO

Features:

- mA module
- MODBUS serial communication



J DIGITAL & DIN DIGITAL

J DIGITAL

Rack mounting (96x48) single reading systems

J DIGITAL control instruments are a series of rack mounting (96x48) single reading systems that meets many applications.

It can set and monitor: pH, ORP, chlorine (depending on the probe: total chlorine, free chlorine, chlorine dioxide, hydrogen peroxide, ozone, bromine or paracetic acid), conductivity, ozone, chlorine dioxide and temperature.

Probes are not included.

J DIGITAL models have: 2 setpoints (on/off, proportional), flow alarm, flow sensor stand-by input, 0-20 mA or 4-20 mA output proportional to read value and programmable in the reading range. Available IP54 protection cover.



DIN DIGITAL

Rail mounting (6 modules) single reading system

DIN DIGITAL control instruments are a series of rail mounting (6 modules) single reading systems that meets many applications.

It can set and monitor: pH, ORP, chlorine (depending on the probe: totalchlorine, free chlorine, chlorine dioxide, hydrogen peroxide, ozone, bromine or paracetic acid), conductivity, ozone, chlorine dioxide and temperature. Probes are not included.

DIN DIGITAL models have: 2 setpoints (on/off, proportional), flow alarm, flow sensor stand-by input, 0-20 mA or 4-20 mA output proportional to read value and programmable in the reading range.



Multiparameter digital controllers

Measurement and control of several parameters simultaneously

pH / Total Chlorine / Free chlorine / Combined Chlorine / ORP / Turbidity Conductivity / Inductive conductivity / Bromine / Ozone + Temperature

LDPHXX series



LDPHXX / LDPHXX PLUS

Options:

- USB for data log recording
- Current Output (0/4 - 20 mA)
- Ethernet
- 3G/4G modem
- MODBUS
- WIFI

LDPHXX PLUS features

- 5 relais (2 setpoint; alarm; probe cleaning; circulation)
- Probe Cleaning
- PID
- mA output



MODELS

LDPHRH / LDPHRH PLUS

pH (0/14) - Redox (0/1000 mV) - °C (0/99,9)

LDPHCL* / LDPHCL* PLUS

pH (0/14) - Cloro (0/10 mg/l Cl₂) - °C (0/99,9)

LDPHBR / LDPHBR PLUS

pH (0/14) - Bromo (0/10 mg/l Br₂) - °C (0/99,9)

LDPHDO / LDPHDO PLUS

pH (0/14) - O₂ (0/200 mg/l H₂O₂) - °C (0/99,9)

Controller for acid (pH) and a second parameter. Wheel with "EASY-NAV" control, Flow control, Local & Remote Controlled,ERMES web communication, Permanent data storage with system log, PT100 temperature probe, Stand-by input, Alarms: damaged probes - max dosage - threshold - levels - flow, Programmable delay at dosing start-up (up to 60 minutes), Priority dosage, Probe readout menu, Probes check up, Multiple probe readings can be viewed, Working modes: on/off, impulsive proportional, proportional PWM and fixed PWM, Automatic or manual dosing activity, Chlorine/Bromine selection with ECL6 (LDPHCL), mA output (option).



Multiparameter digital controllers

Measurement and control of several parameters simultaneously

pH / Total Chlorine / Free chlorine / Combined Chlorine / ORP / Turbidity Conductivity / Inductive conductivity / Bromine / Ozone + Temperature

CENTURIO POOL series



CENTURIO

Options:

- USB for data log recording
- Current Output (0/4 - 20 mA)
- Ethernet
- 3G/4G modem
- MODBUS RTU & TCP/IP
- WIFI



RANGES

pH

from 0 to 14 pH

Bromine

from 0 to 10 mg/l

ORP

from -1000 to 1000 mv

Turbidity

from 0 to 4000 NTU

Total chlorine

from 0 to 20 mg/l

Temperature

from 0 to 100 °C

Free chlorine

from 0 to 20 mg/l

Conductivity

from 0 to 300 mS

Combined chlorine

from 0 to 10 mg/l

CENTURIO POOL is a digital regulation and measurement system for multi-parameter control in swimming pool water treatment. It combines complete control and extreme ease of use with the elegance of the case made by Giugiaro Design.

Equipped with a Linux operating system, a high-performance ARM A5 microprocessor and a large color touchscreen, CENTURIO POOL can be set to work with pH priorities and can control flocculant output, shock chlorination and backwashing of filters and simultaneously manage up to 10 channels to read the following parameters: pH, free chlorine, combined chlorine, active free chlorine, total chlorine, conductivity, ORP, NTU, product levels, pool water level. For each channel CENTURIO POOL has 2 digital setpoints (ON / OFF), 2 proportional setpoints (IS), 1 mA output setpoint and 1 Temperature setpoint; you can also set 6 timers with a maximum of 10 daily schedules each.

CENTURIO POOL can be connected to the Internet via WIFI, GSM or ETHERNET and remotely controlled via ERMES, the online control system designed by EMEC. It is also equipped with the MODBUS serial communication protocol (optional) which allows connection with other devices within RS485 networks.



Sale : Ms Dung 0918077755

E: dung.nguyen@vietthaiqua.com

YOUR POOL ONLINE





Remote measurement and control

ERMES

Through ERMES online service you can remotely control and regulate all the parameters of all EMEC enabled products and interactively monitor probes, instrument inputs, products level, temperature and setpoints.

ADVANTAGES

- Less plant intervention and inspections.
- Reports on the current status of the network's devices and connections (probes, outputs, alarms, setpoints)
- Instant alarm notifications via sms or email
- Data report of all plant instruments
- Activity log like graphs and charts that can be downloaded on your PC (excel or pdf)

HOW DOES ERMES WORK?

Enter www.ermes-server.com, register for free, configure and name your systems. All EMEC instruments with encoder and ETHERNET or 3G/4G configuration will be immediately connected and available.

In addition to the remote control, through ERMES you can receive, via email, alarm messages with various report options on the status of your systems. If you have an instrument with 3G/4G configuration you can also receive reports on your phone via SMS.

On request, the instruments can be supplied with a SIM card and mobile data subscription (only on instruments equipped with a 3G/4G module. Subscription paid by the customer).

EMEC compatible systems:

- CENTURIO
- LDS
- MTOWER
- WD

CONFIGURATION	FEATURES	CONNECTION TYPE	REQUIREMENTS	FUNCTIONS
BASIC	/	/	/	RS485 link to EMEC instruments
ADVANCED USB	USB	Download data log from controller to Usb drive	/	RS485 link to other EMEC instruments Data Log recording on USB drive
ETHERNET	LAN network	Remote control via WEB APP ERMES (www.ermes-server.com)	LAN (RJ-45) network	RS485 link to other EMEC instruments ERMES Web App (PC, smartphone, tablet) Email Alarm messages
3G/4G	MOBILE connection	Remote control via WEB APP ERMES (www.ermes-server.com)	Mobile Network Coverage	RS485 link to other EMEC instruments ERMES Web App (PC, smartphone, tablet) Email/SMS Alarm messages
MODBUS	PLC connection to other devices via RS485 or TCP/IP (only Centurio)	PLC plant management	/	PLC connection output for parameters reading/setting
WIFI	WIFI connection between instrument and web	Remote control via WEB APP ERMES (www.ermes-server.com)	WIFI Network Coverage	RS485 link to other EMEC instruments ERMES Web App (PC, smartphone, tablet) Email Alarm messages

Remote measurement and control

CONNECTION EXAMPLE

ETHERNET - WIFI

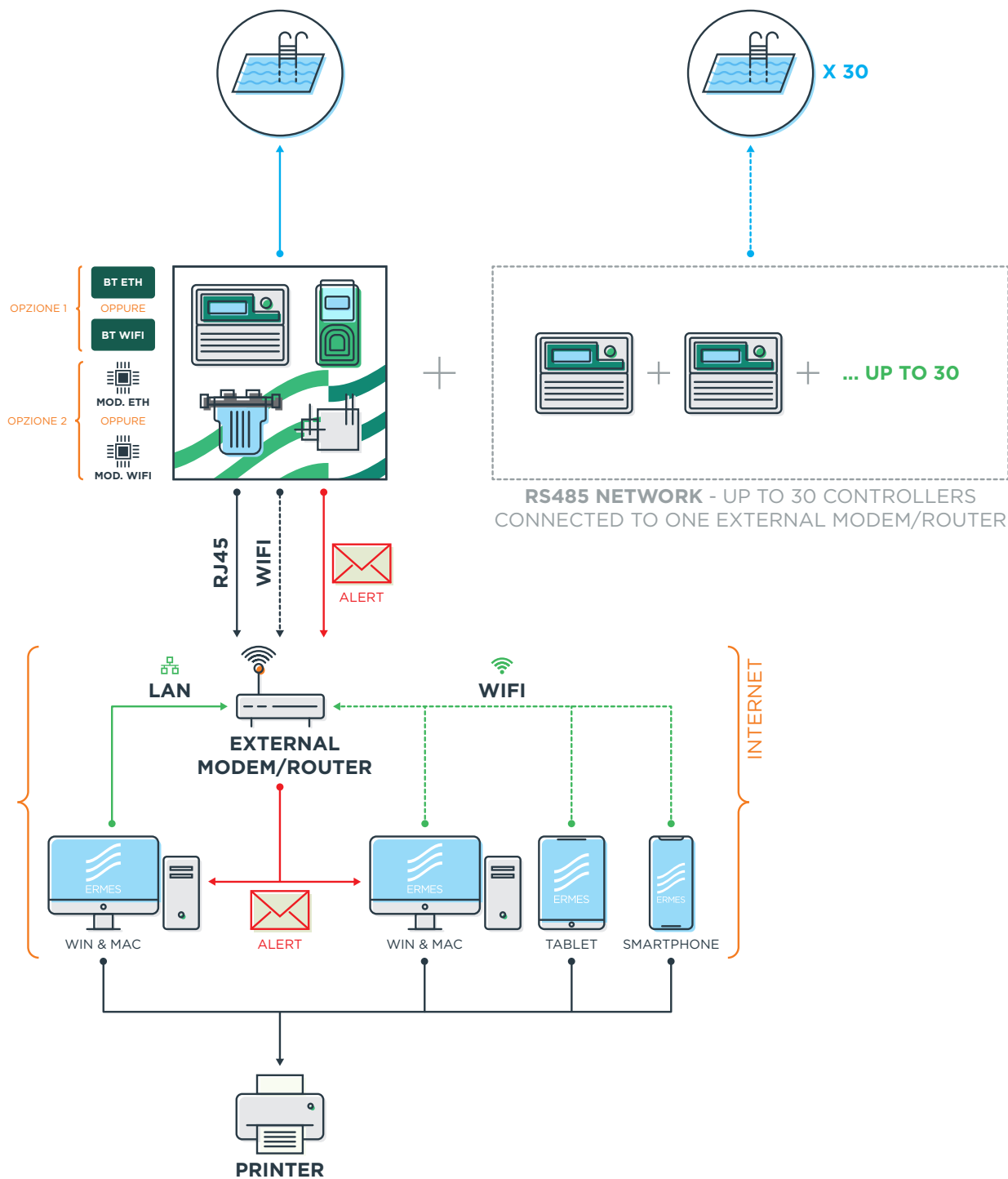



CONNECTION EXAMPLE

GSM - 3G/4G

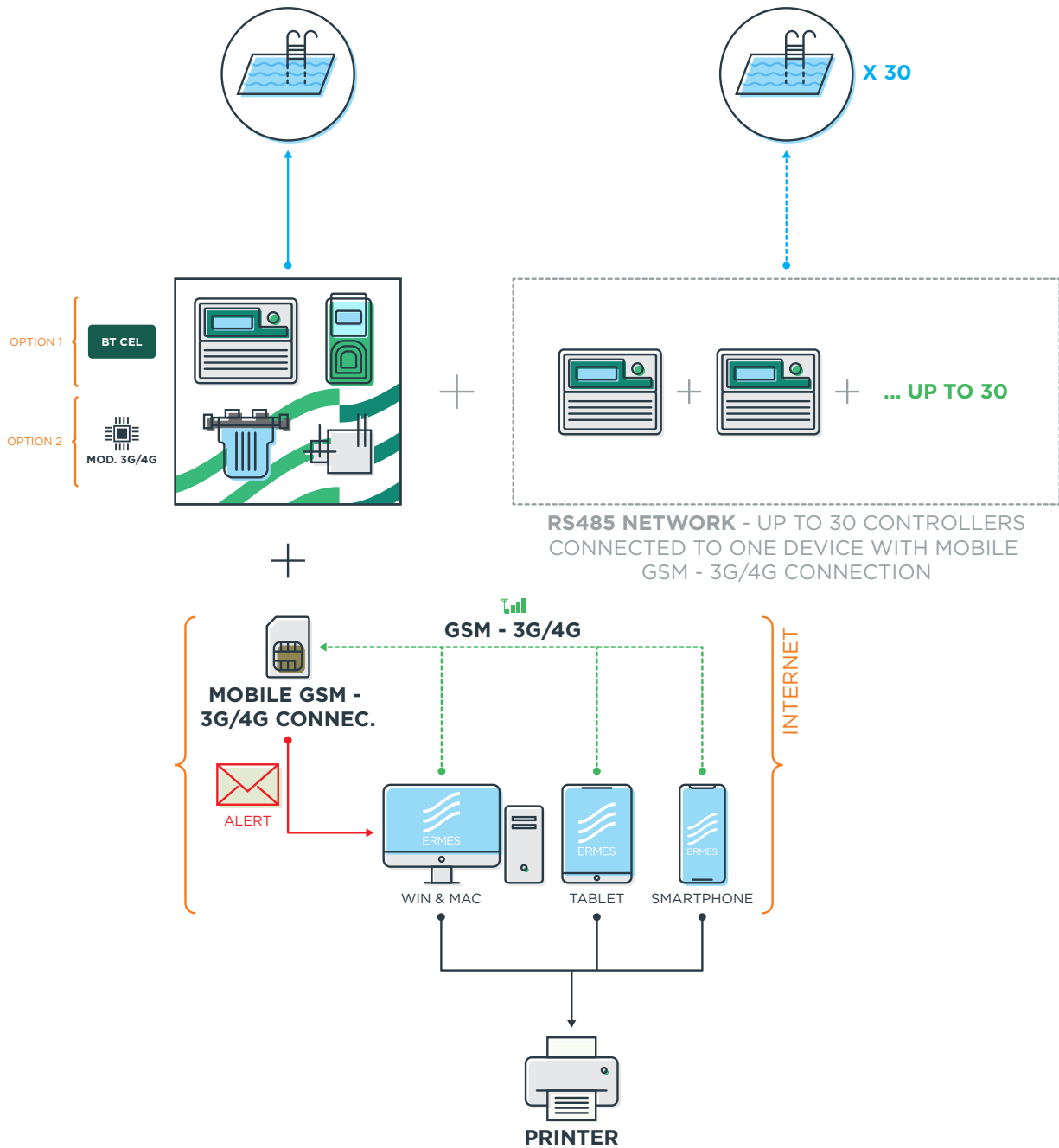

Remote measurement and control

CONNECTION EXAMPLE

DATA DOWNLOAD & UPLOAD VIA USB

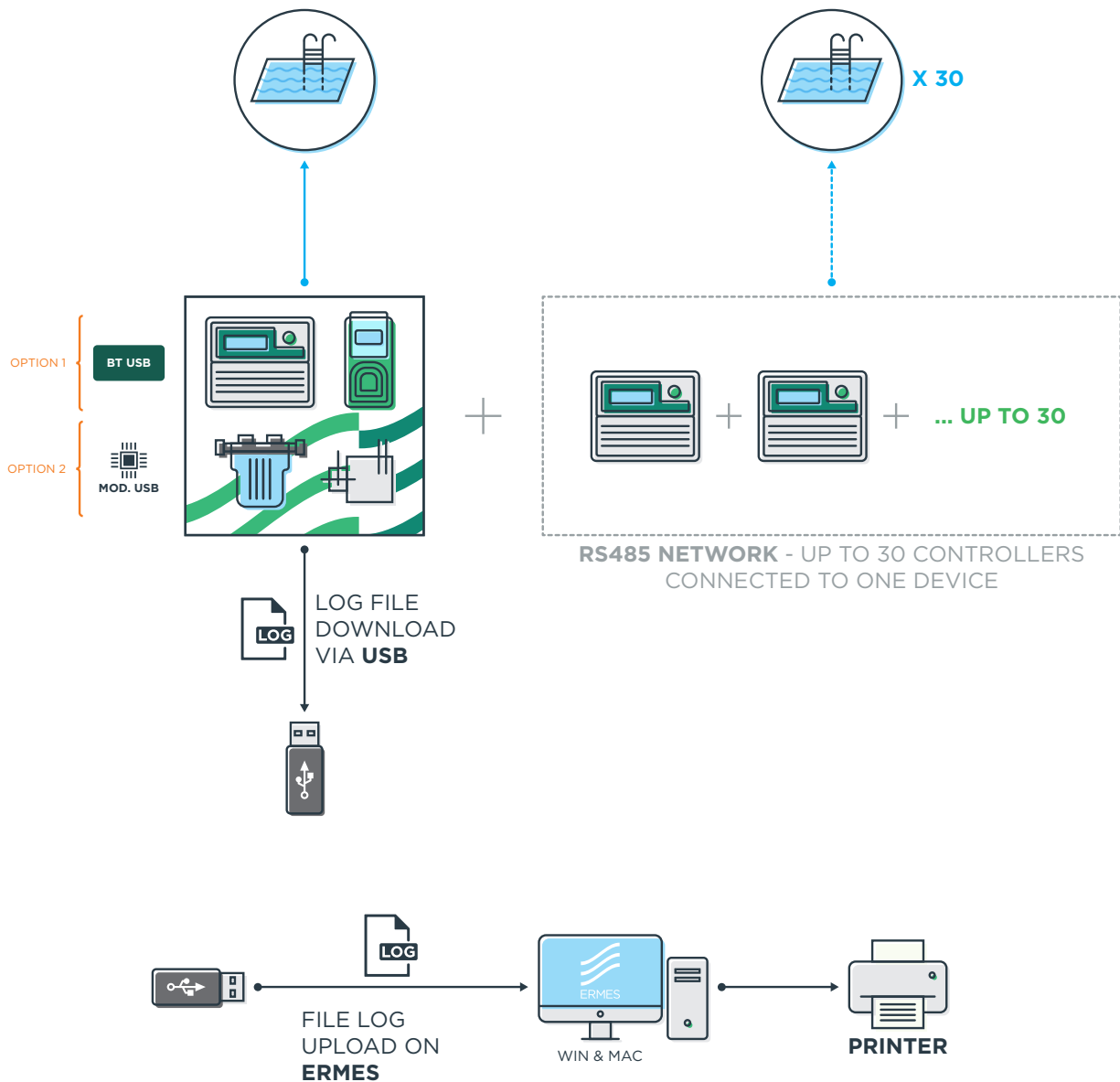

Modem and external communication modules 48/49

For LD, WDPHXX and CENTURIO controller series

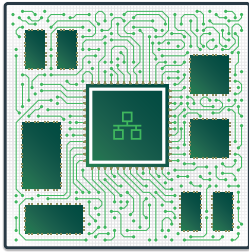

ETHERNET MODULE
Internal standard ETHERNET (RJ45) controller for LD encoder.

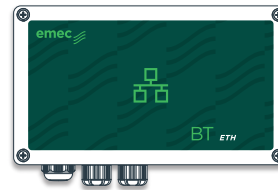

BT ETH
Ethernet controller for standard RJ45 network. IP65.

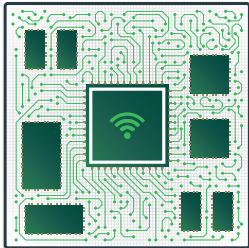

WIFI MODULE
Module for WIFI network. IP65.



BT WIFI
Module for WIFI connection. IP65.

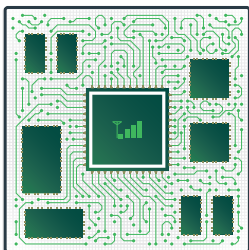

3G/4G MODULE
Internal 3G/4G modem for LD encoder.

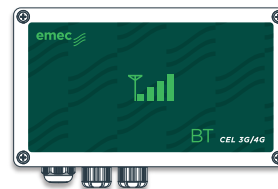

BT CEL
Modem for mobile network. IP65.

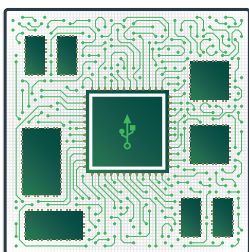

USB MODULE
Module for USB connection. IP65.

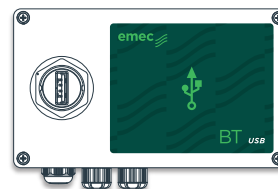

BT USB
USB module for USB datalog recording. IP65.

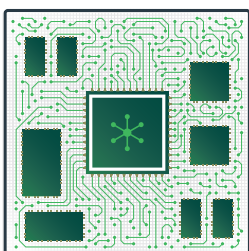

MODBUS MODULE
MODBUS RTU module for PLC connection.



BT MODBUS
Serial communication module for PLC connection.

All-in-one systems

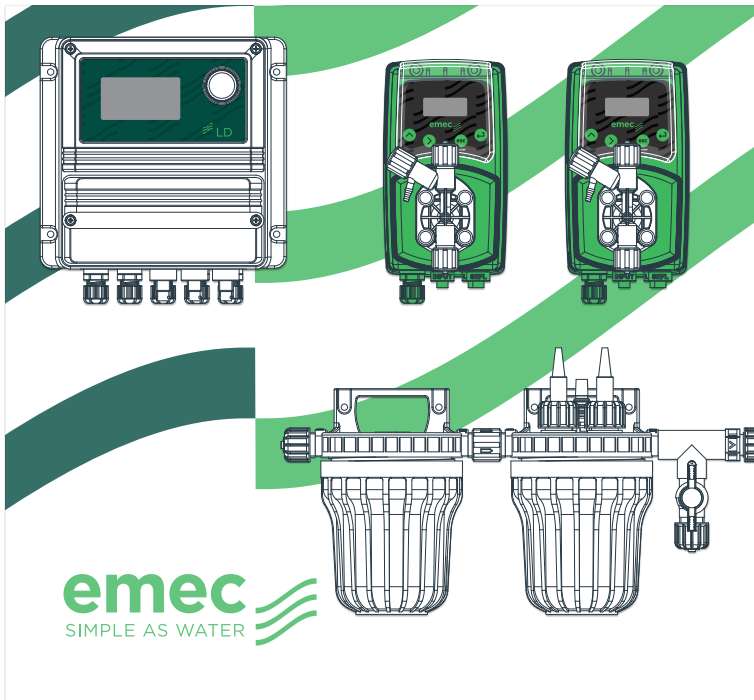

PA-LDPHRH

PH AND ORP PROPORTIONAL CONTROL

- Controller LDPHRH
- Dosing pump VMS MF 03 10 (10 l/h)
- Dosing pump VMS MF 03 10 (10 l/h)
- Filter NFIL
- pH probe EPHS
- ORP probe ERHS
- Probe holders NPED4

Size: 600x650 mm

Customized coloured background on demand

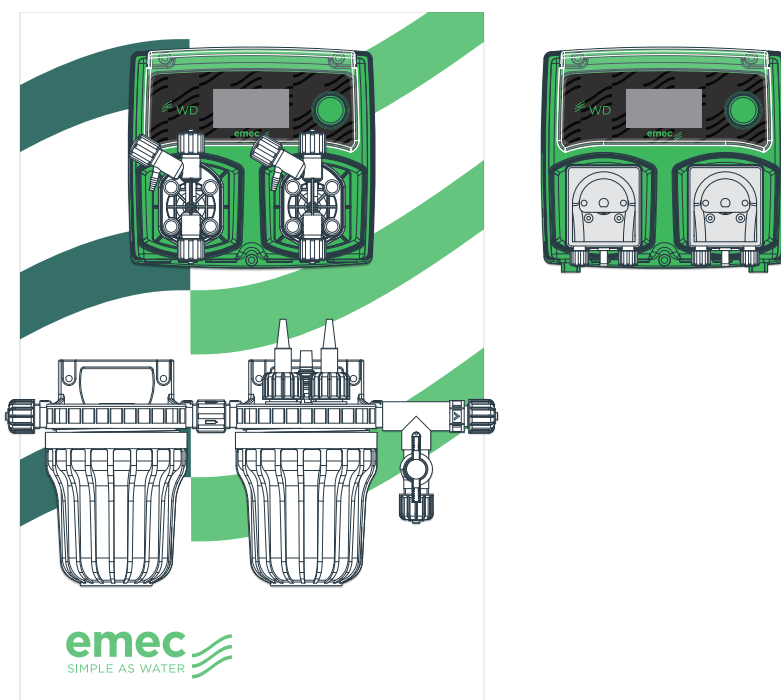

PA-WDPHOS

PH AND ACTIVE OXYGEN PROPORTIONAL CONTROL

- Controller WDPHOS 03 10 (10 l/h) and 03 04 (4 l/h), or WDPHOS PER 01 03 (with peristaltic dosing pumps)
- Filter NFIL
- Temperature probe ETEPTCH18
- pH probe EPHS
- Probes holder NPED4

Optional: Also available with WDPHOS PER

Size: 400x600 mm

Customized coloured background on demand.

OUTPUT **RS485**

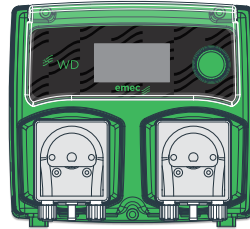
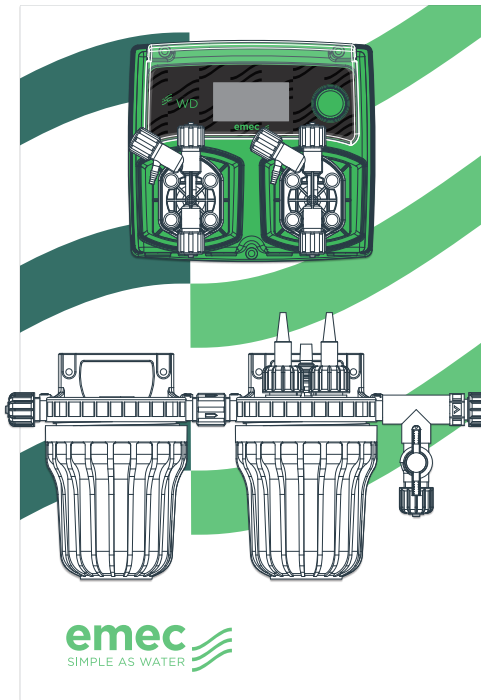

PH AND ORP PROPORTIONAL CONTROL

- Controller WDPHRH 03 10 (10 l/h), 05 01 (1 l/h) and 10 04 (4 l/h), or WDPHRH PER 01 03 (with peristaltic dosing pumps).
- Filter NFIL
- Probe ORP ERHS
- Probe pH EPHS
- Probes holder NPED4

Optional: Also available with WDPHRH PER

Size: 400x600 mm
Customized coloured background on demand.

OUTPUT **RS485**

PA-WDPHEV

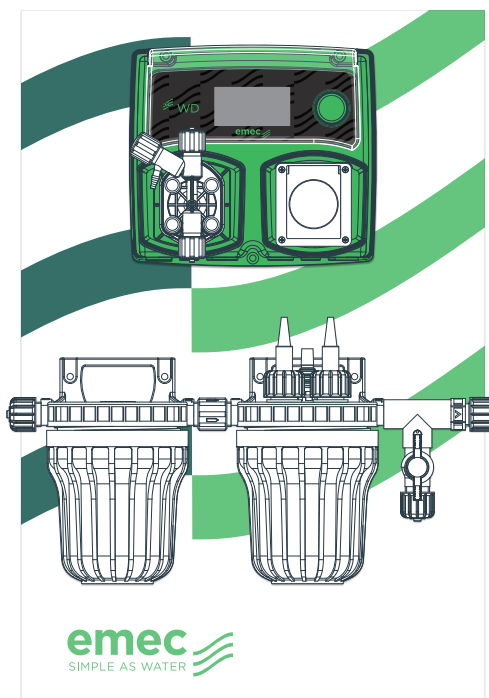

PH OR ORP PROPORTIONAL CONTROL, DRY FEEDER SOLENOID VALVE OR SALT GENERATOR (230VAC / 10A) OUTPUT

- Controller WDPHRHS 07 06 (6 l/h) or 05 01 (1 l/h) 2. Filter NFIL
- Probe ORP ERHS
- Probe pH EPHS
- Probes holder NPED4

Size: 400x600 mm
Customized coloured background on demand.

OUTPUT **RS485**

All-in-one systems

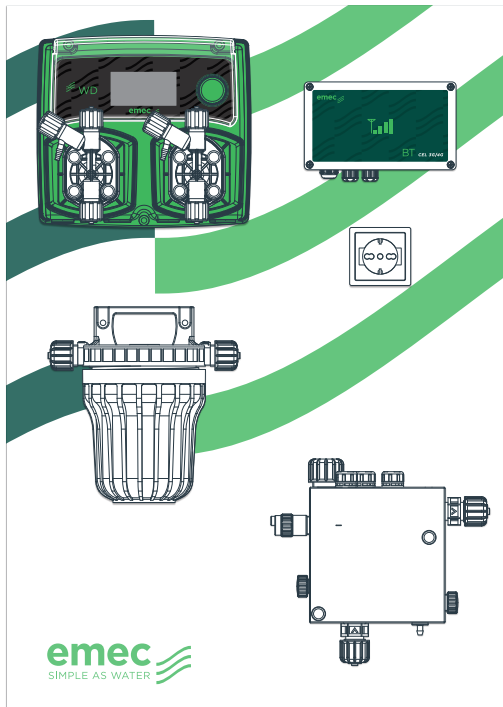

PA-WDPHCFS/PA-WDPHCASA

SALT CHLORINE GENERATOR VERSION:

*Flocculant with continuous dosing PA-WDPHCFS/PA-WDPHCASA
Anti algae with weekly timer PA-WDPHCASA*

- Controller WDPHCA 07 06 (6 l/h), 05 01 (1 l/h) or 10 04 (4 l/h)
- Probe pH EPHS
- Filter NFIL
- Proximity sensor SEPR
- Open amperometric cell ECL6
- Modem BT CEL
- Output 10 A 220 VAC

Optional: Free of voltage EV contact.

Size: 500x700 mm

Customized coloured background on demand.

OUTPUT **RS485**

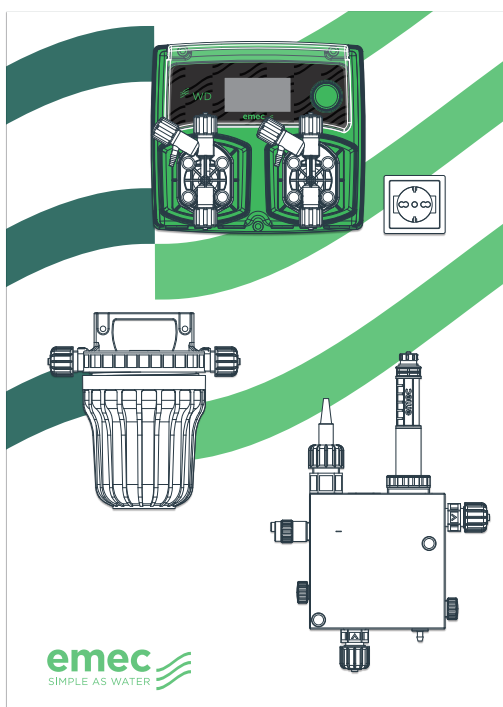

PA-WDPHCA/CF/PA-WDPHBA/BF

CHLORINE / BROMINE DRY FEEDER:

*Flocculant with continuous dosing PA-WDPHCFB/PA-WDPHBA/BF
Anti algae with weekly timer PA-WDPHCA/CF*

- Controller WDPHCL 07 06 (6 l/h), 05 01 (1 l/h) or 10 04 (4 l/h)
- Probe pH EPHS
- Chlorine probe SCL3S/20 or Bromine probe SBR 1/20
- Filter NFIL
- Proximity sensor SEPR
- Probes holder PEFIR
- Output 10 A 220 VAC

Optional: Free of voltage EV contact.

Size: 500x700 mm

Customized coloured background on demand.

OUTPUT **RS485**



PA-WDPHCL

PH AND CHLORINE PROPORTIONAL CONTROL

- Controller WDPHCL 07 06 (6 l/h), 05 01 (1 l/h) or 10 04 (4 l/h), or WDPHCL PER 01 03 (with peristaltic dosing pumps).
- Filter NFIL
- Proximity sensor SEPR
- Probe pH EPHS
- Open amperometric cell ECL6

Optional: Also available with WDPHCL PER

Size: 500x700 mm

Customized coloured background on demand.

OUTPUT **RS485**

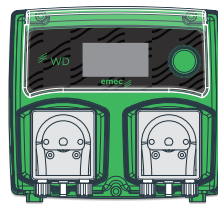
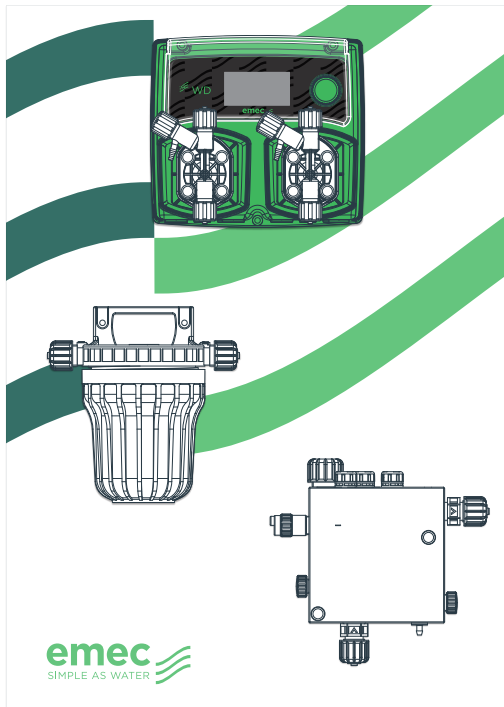

PA-WDPHCLO

PH AND CHLORINE PROPORTIONAL CONTROL (INORGANIC/ORGANIC)

- Controller WDPHCL 07 06 (6 l/h), 05 01 (1 l/h) or 10 04 (4 l/h), or WDPHCL PER 01 03 (with peristaltic dosing pumps).
- Filter NFIL
- Proximity sensor SEPR
- Probe pH EPHS
- Chlorine probe SLC3S/20
- Probes holder PEF1R

Optional: Also available with WDPHCLO PER

Size: 500x700 mm

Customized coloured background on demand.

OUTPUT **RS485**

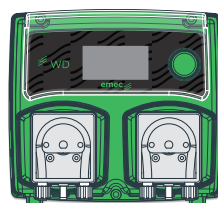
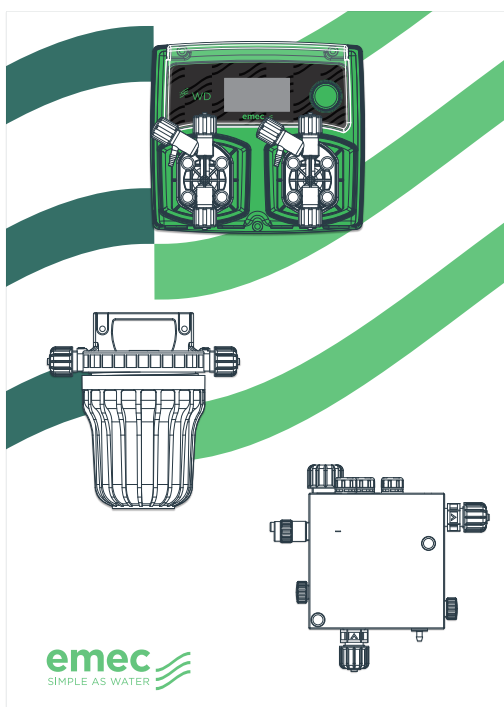

All-in-one systems

Controller based system with open amperometric cell ECL6

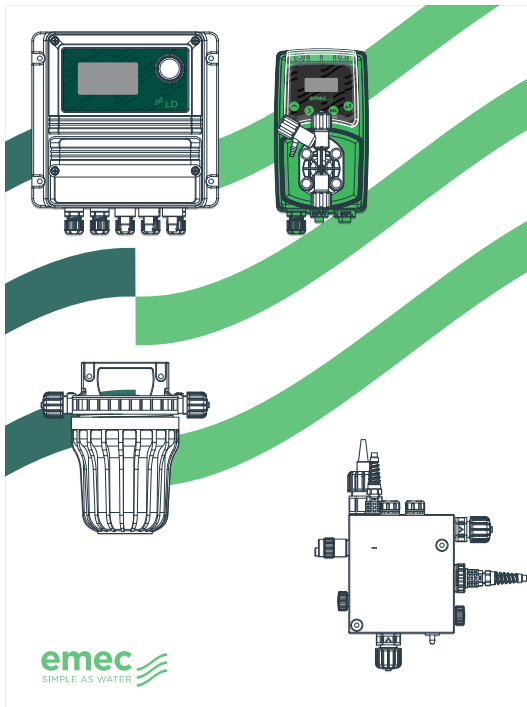

PA-LDPHCL

**FOR DRY FEEDER USAGE (CHLORINE / BROMINE) OR SALT CHLORINE GENERATOR.
MEDIUM SIZE POOL**

- Controller LDPHCL
- Dosing pump for acid VMS MF 03 10 (10 l/h) 3.
Filter NFIL
- Probe pH EPHS
- Proximity sensor SEPR
- Temperature probe ETEPTCH18
- Open amperometric cell ECL6

Size: 600x800 mm

Customized coloured background on demand.

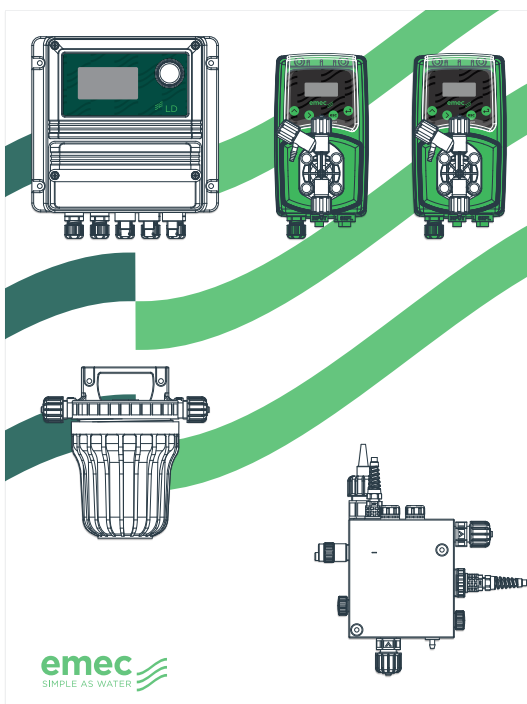

PA-LDPHCLO

**PH AND CHLORINE PROPORTIONAL CONTROL.
MEDIUM SIZE POOL**

- Controller LDPHCL
- Dosing pump for acid VMS MF 03 10 (10 l/h)
- Dosing pump for chlorine VMS MF 02 15 (15 l/h)
- Filter NFIL
- Probe pH EPHS
- Proximity sensor SEPR
- Temperature probe ETEPTCH18
- Open amperometric cell ECL6

Size: 600x800 mm

Customized coloured background on demand.

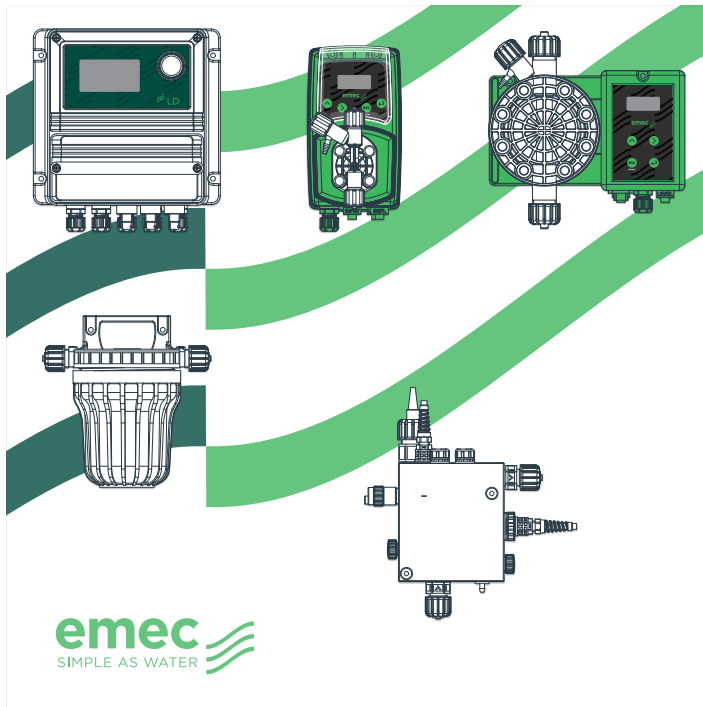

emec
SIMPLE AS WATER

PA-LDPHCLOB

FOR PH AND CHLORINE PROPORTIONAL CONTROL. LARGE SIZE POOL

- Controller LDPHCL
- Dosing pump for acid VMS MF 02 15 (15 l/h)
- Dosing pump for chlorine TMS MF 03 30 (30 l/h)
- Filter NFIL
- Probe pH EPHS
- Proximity sensor SEPR
- Temperature probe ETEPTCH18
- Open amperometric cell ECL6

Size: 800x800 mm
Customized coloured background on demand.

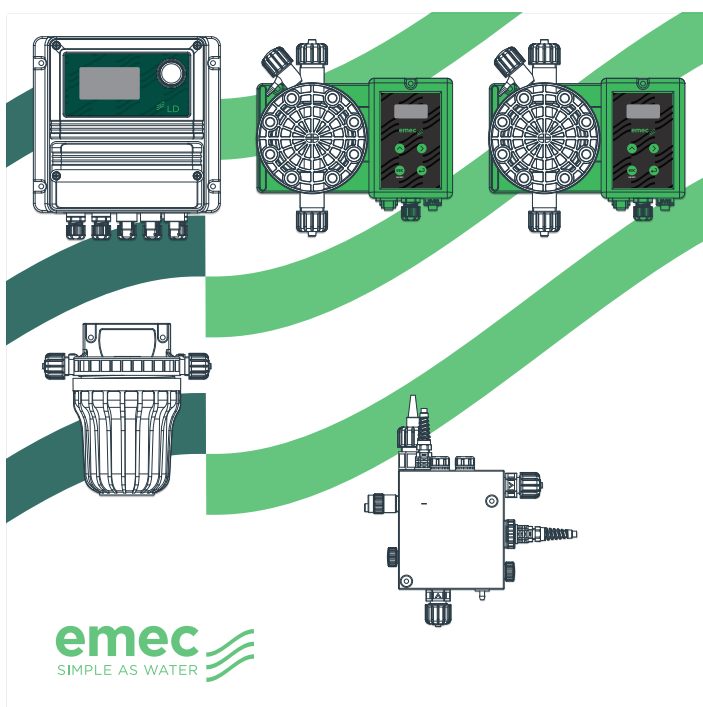

emec
SIMPLE AS WATER

PA-LDPHCLOBG

FOR PH AND CHLORINE PROPORTIONAL CONTROL. LARGE SIZE POOL

- Controller LDPHCL
- Dosing pump for acid TMS MF 03 30 (30 l/h)
- Dosing pump for chlorine TMS MF 01 50 (50 l/h)
- Filter NFIL
- Probe pH EPHS
- Proximity sensor SEPR
- Temperature probe ETEPTCH18
- Open amperometric cell ECL6

Size: 800x800 mm
Customized coloured background on demand.

All-in-one systems

Controller based system with closed amperometric cell SCL3S/20 and PEF1

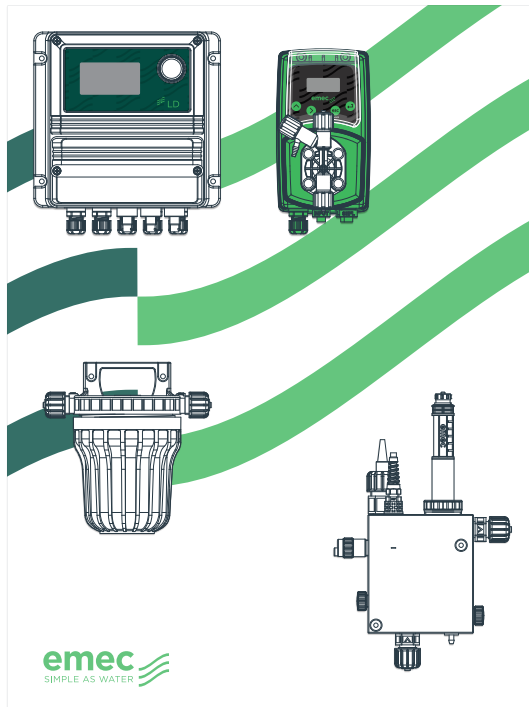

PA-LDPHCLV & PA-LDPHBR

FOR DRY FEEDER OR SALT CHLORINE GENERATOR. MEDIUM SIZE POOL

- Controller LDPHCL
- Dosing pump for acid VMS MF 03 10 (10 l/h)
- Filter NFIL
- Proximity sensor SEPR
- Probe pH EPHS
- Chlorine probe SCL3S/20
- Temperature probe ETEPTCH18
- Probes holder PEF1R

PA-LDPHBR: Also available with bromine probe EBR 1/20.

Size: 600x800 mm
Customized coloured background on demand.

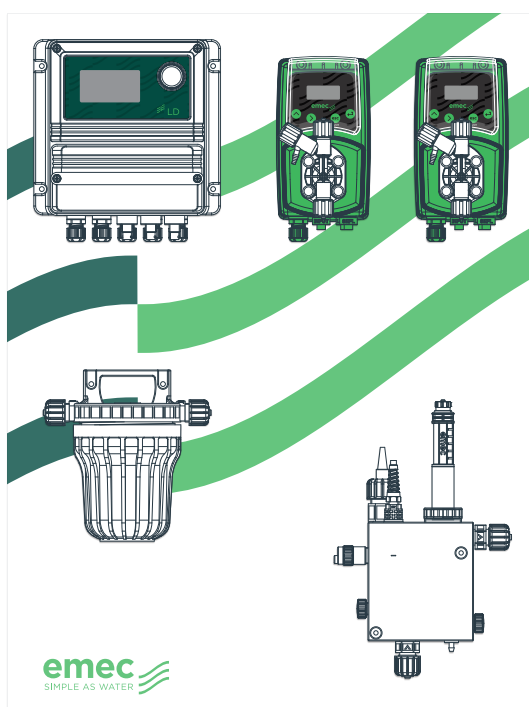

PA-LDPHCLVD

PH AND CHLORINE PROPORTIONAL CONTROL (INORGANIC/ORGANIC). MEDIUM SIZE POOL

- Controller LDPHCL
- Dosing pump for acid VMS MF 03 10 (10 l/h)
- Dosing pump for chlorine VMS MF 02 15 (15 l/h)
- Filter NFIL
- Proximity sensor SEPR
- Probe pH EPHS
- Chlorine probe SCL3S/20
- Temperature probe ETEPTCH18
- Probes holder PEF1R

Size: 600x800 mm
Customized coloured background on demand.

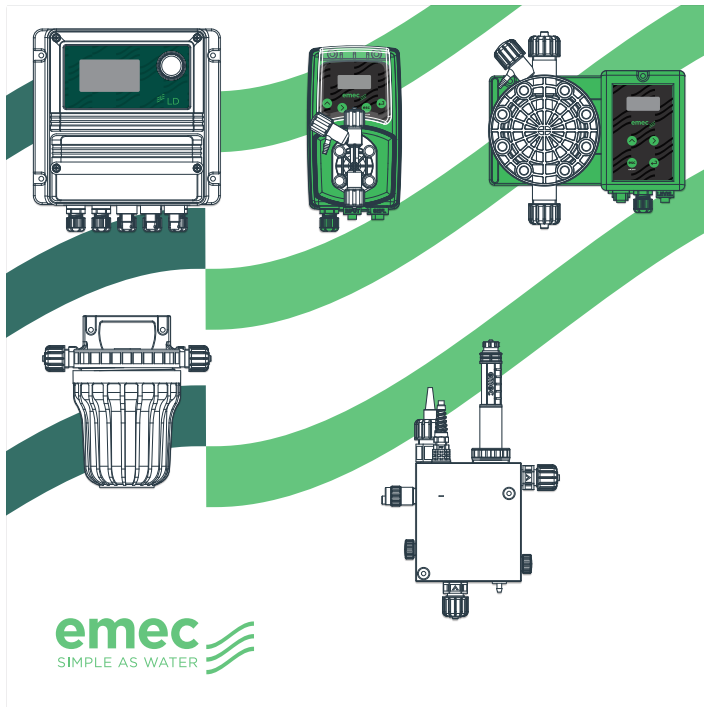

PA-LDPHCLVG

PH AND CHLORINE PROPORTIONAL CONTROL (INORGANIC/ORGANIC). BIG SIZE POOL

- Controller LDPHCL
- Dosing pump for acid VMS MF 02 15 (15 l/h)
- Dosing pump for chlorine TMS MF 03 30 (30 l/h)
- Filter NFIL
- Proximity sensor SEPR
- Probe pH EPHS
- Chlorine probe SCL3S/20
- Probes holder PEF1R

Size: 800x800 mm
Customized coloured background on demand.

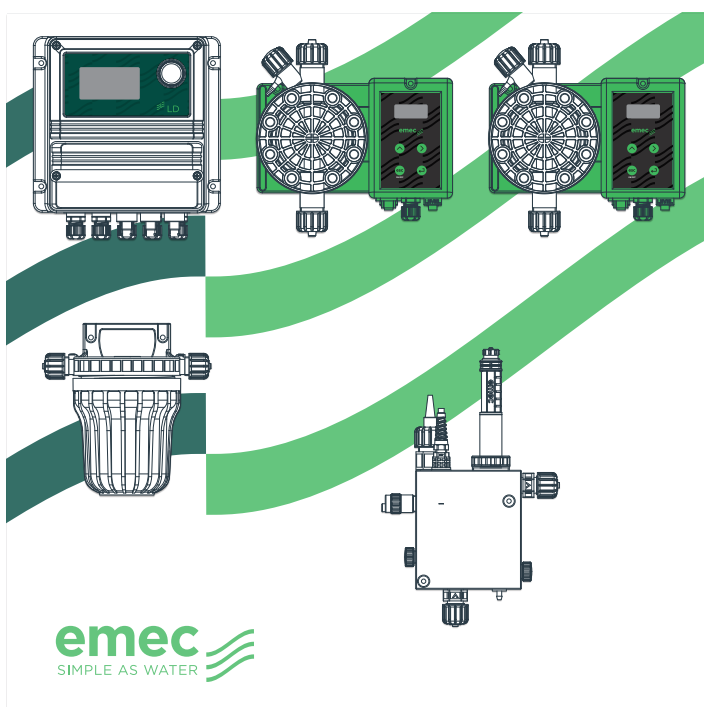

PA-LDPHCLGD

PH AND CHLORINE PROPORTIONAL CONTROL (INORGANIC/ORGANIC). BIG SIZE POOL

- Controller LDPHCL
- Dosing pump for acid TMS MF 03 30 (30 l/h)
- Dosing pump for chlorine TMS MF 01 50 (50 l/h)
- Filter NFIL
- Proximity sensor SEPR
- Probe pH EPHS
- Chlorine probe SCL3S/20
- Probes holder PEF1R

Size: 800x800 mm
Customized coloured background on demand.

Advanced all-in-one systems

PA-CED

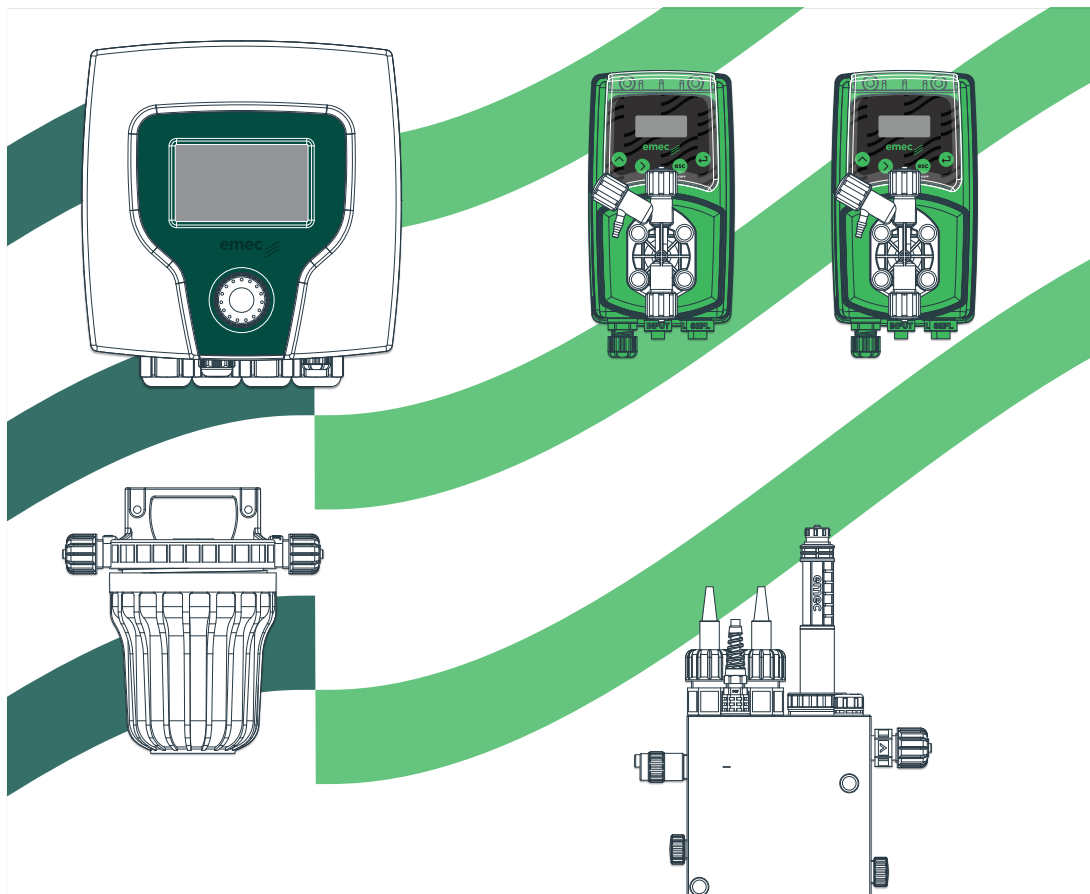

PH, ORP, FREE CHLORINE AND TEMPERATURE CONTROL

- Controller CENTURIO POOL
- Dosing pump for acid VMS MF 03 10 (10 l/h)
- Dosing pump for chlorine VMS MF 02 15 (15 l/h)
- Filter NFIL
- Probe EPHS di pH
- Probe SCL3S/20 Free chlorine
- Proximity sensor SEPR
- Temperature probe ETEPTCH18
- Probe ERHS di ORP
- Probes holder PEFIR

Optional: also available with Centurio Pool controller

Size: 800x800 mm
Customized coloured background on demand.

The images contained in these pages are for illustrative purposes only. For more information on possible configurations, contact the sales office or your sales representative.



PA-CEDB

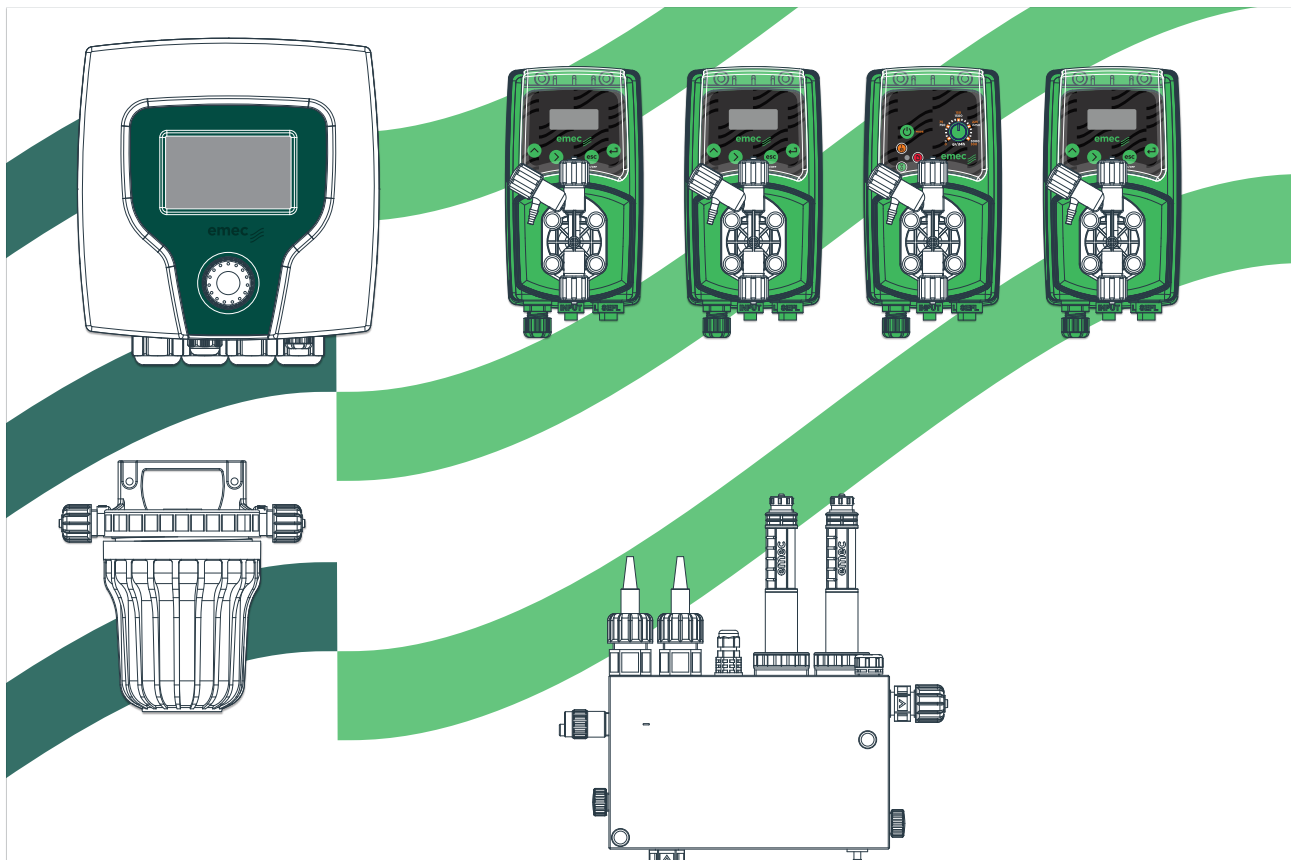

PH, ORP, FREE CHLORINE, TOTAL CHLORINE, COMBINED CHLORINE AND TEMPERATURE ANTI ALGAE AND FLOCCULANT TREATMENT

- Controller CENTURIO POOL
- Dosing pump for acid VMS MF 03 10 (10 l/h)
- Dosing pump for chlorine VMS MF 02 15 (15 l/h)
- Dosing pump for flocculant VCLG
- Dosing pump for anti algae VMS MF 07 06 (6 l/h)
- Filter NFIL
- Probe di pH EPHS
- ORP probe ERHS
- Temperature probe ETEPTCH18
- Free chlorine probe SCL3S/20
- Total chlorine probe SCL8/20
- Proximity sensor SEPR
- Probes holder PEF22R

Optional: also available with Centurio Pool controller

Size: 1000x800 mm
Customized coloured background on demand.

Advanced all-in-one systems

PA-CEDV

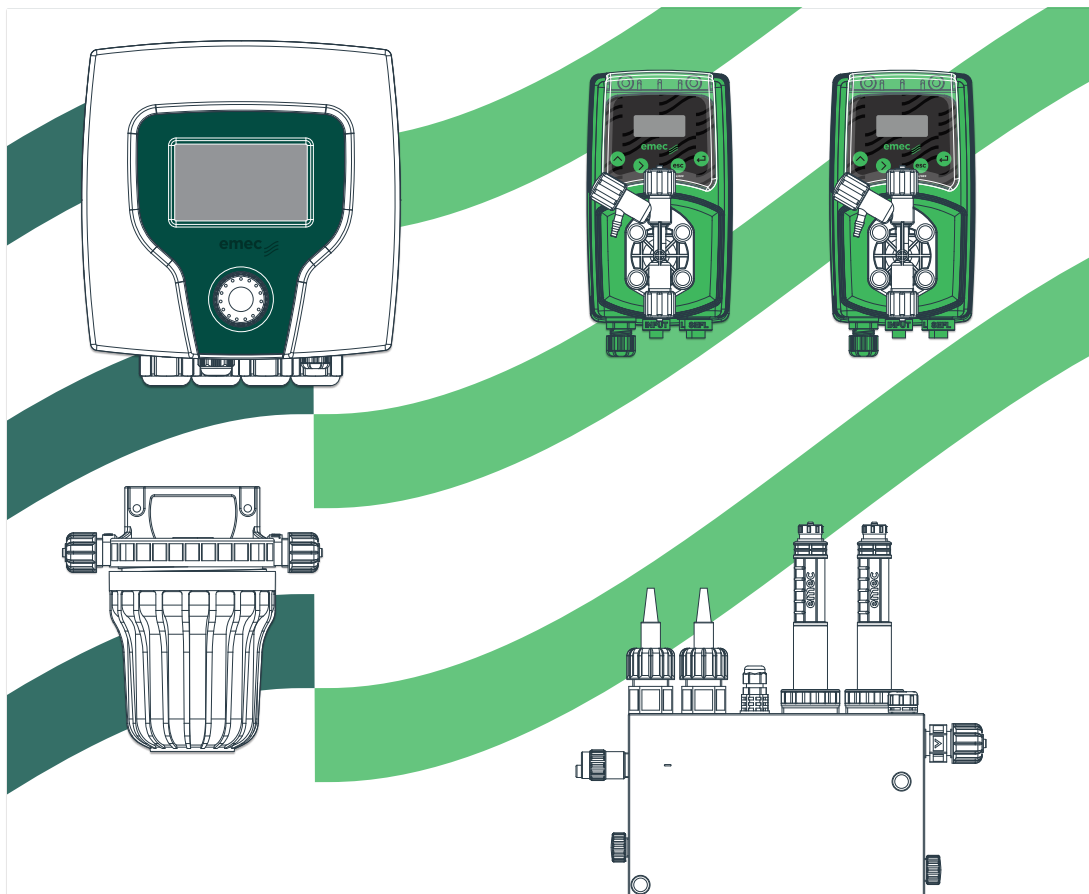

PH, ORP, FREE CHLORINE, TOTAL CHLORINE, COMBINED CHLORINE AND TEMPERATURE

- Controller CENTURIO POOL
- Dosing pump for acid VMS MF 03 10 (10 l/h)
- Dosing pump for chlorine VMS MF 02 15 (15 l/h)
- Filter NFIL
- Probe di pH EPHS
- ORP probe ERHS
- Temperature probe ETEPTCH18
- Free chlorine probe SCL3S/20
- Total chlorine probe SCL8/20
- Proximity sensor SEPR
- Probes holder PEF22R

Optional: also available with Centurio Pool controller

Size: 800x800 mm
Customized coloured background on demand.

The images contained in these pages are for illustrative purposes only. For more information on possible configurations, contact the sales office or your sales representative.



PA-CEDT

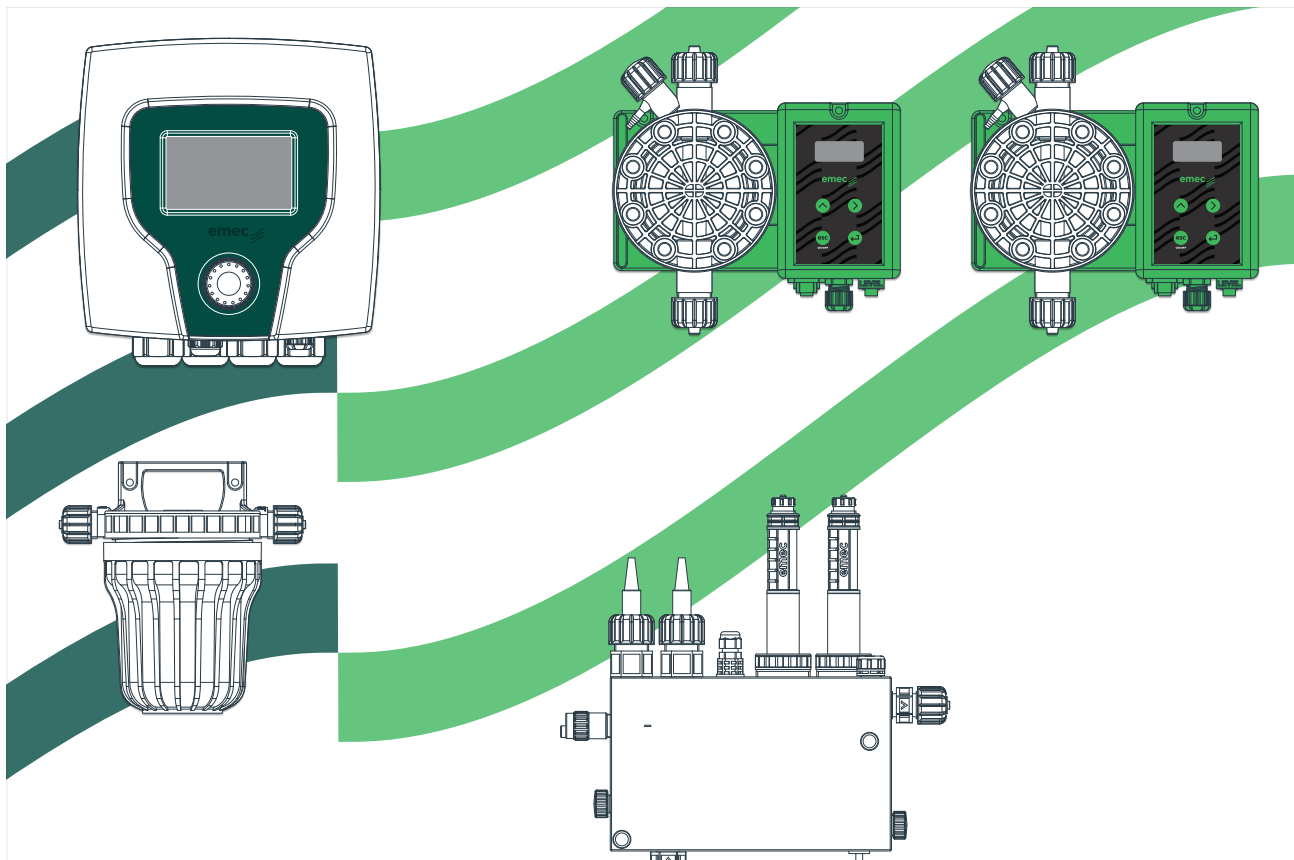

PH, ORP, FREE CHLORINE, TOTAL CHLORINE, COMBINED CHLORINE AND TEMPERATURE

- Controller CENTURIO POOL
- Dosing pump for acid TMS MF 03 30 (30 l/h)
- Dosing pump for chlorine TMS MF 01 50 (50 l/h)
- Filter NFIL
- Probe di pH EPHS
- ORP probe ERHS
- Temperature probe ETEPTCH18
- Free chlorine probe SCL3S/20
- Total chlorine probe SCL8/20
- Proximity sensor SEPR
- Probes holder PEF22R

Optional: also available with Centurio Pool controller

Size: 1000x800 mm
Customized coloured background on demand.

Accessories



EPHS
pH electrode for pressures up to 7 bar/70°C (3.5 bar/80°C). 0.8 m cable. Epoxy body. Minimum 100 µS.



ERHS
ORP electrode for pressures up to 7 bar/70°C (3.5 bar/80°C). 0.8 m cable. Epoxy body. Minimum 100 µS.



BUFFER SOLUTIONS
Buffer solutions for probes calibration.



SCL8
Total chlorine amperometric cell (organic and inorganic), from 0 to 2 mg/l; from 0 to 20 mg/l, pH and temperature compensated.

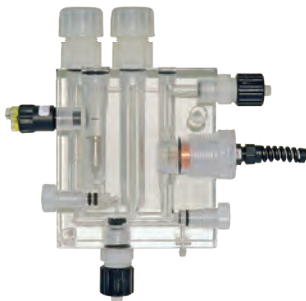

ECL6 / ECL12
Free chlorine / bromine amperometric cell (organic and inorganic), from 0 to 10 mg/l. Flow switch and flow adjustment. Electrodes holder for pH, Redox and temperature. With proximity switch mod. SEPR. 6x8 fittings. With LED light sold as option.



SCL3S/20
Free chlorine amperometric cell (organic and inorganic), from 0 to 10 mg/l, pH and temperature compensated.



ETEPT
Temperature probe PT100 (0°C÷100 °C, max 10bar). Suitable for LDxx, LDPHxx series instruments.



PEF22R
Holder for Chlorine, pH, Redox, free Chlorine, total Chlorine and temperature probes. Provided type SEPR flow controller. With LED light sold as option.



PEF1R
Off-line probes holder for ECL1/2/3/8/9/10/11 and pH, Redox and temperature, with flow switch and regulation. With proximity switch mod. SEPR. 6X8 fittings. With LED light sold as option.



NFIL CA
Activated 5" filter with carbon filter cartridge. 6x8 fittings. With LED light sold as option.



NFIL
Filter with cartridge. Washable. PET (60 µ). 6x8 fittings. With LED light sold as option.



NPED4
Off-line electrode holder for EPH and ERH electrodes. Epoxy Ø12 casing. Max temperature 50° C, max pressure 5bar with flow sensor, N.O. switch, 6x8 fittings. With LED light sold as option.



EVLA
Electrovalve for dry feeder (chlorine / bromine). 1/2" fitting.



PELC
PVDF in-line electrode holder for pH / Redox electrodes with 1/2" or 3/4" thread. For saddle connection.



PEL
PVDF in-line electrode holder for pH / Redox electrodes with 1/2" or 3/4" thread. For "T" connection.



SBR1/20
Amperometric cell for bromine (reading range from 0 to 20 mg/l), pH and temperature compensated.

Accessories



MIXVN/8
High speed mixer 1400 RPM. AISI shaft-PVC coated, different lengths available (630-730-830-930 mm). Marine impeller, diameter 70mm.



MIXN/8
Slow speed mixer 70/200 RPM. AISI shaft-PVC coated, different lengths available (630-730-830-930 mm). 3-blade impeller, diameter 150mm.



MIXN/MAN
Manual mixer. PVC shaft, different lengths available (500-600 and 700-800 mm). Impeller diameter 130 mm.



MIX "PISTON"
Manual mixer. PVC shaft, different lengths available (500-600 and 700-800 mm). Impeller diameter 130 mm.



LASP
Suction lances with level control, for tanks up to 25 liters.



LASP
Suction lances with level control, for tanks up to 1000 liters.



LINIR
1/2" injection lance for dosing sodium hypochlorite in hard water. Self cleaning. FKM B o-ring. PVC body.



PVDF INJECTION VALVE
PVDF made injection valve with 1/2" or 3/4" fittings.



MF MULTIFUNCTION VALVE
Multifunction valve (pressure, safety, antisiphon and bleed) 1/2" connections for different hoses diameters. FKM B or EPDM o-ring. PVDF body.



LEVEL PROBE with FOOT FILTER
Level probe with REED TYPER CONTACT. High temperature resistant, not influenced by viscosity, opacity, conductivity or dielectric constant (0 e 60°C).



CHEMICAL TANKS & SAFETY BUNDS

Chemical tanks made of polyethylene, UV resistant with safety bunds. For dosing pumps and mixers.



CALCIUM HYPOCHLORITE DOSING STATIONS

Our chemical tanks can be assembled with:

- 1 Dosing pump (or 2 without mixer) - 1 mixer
- 1 water loading faucet
- 1 outgassing valve
- 1 or 2 suction lances
- 1 water purging faucet
- 2 level probes with filter (without mixer)

Assembling made with two dosing pumps must use a double-suction lance and KDPV kit for connecting both the pumps.

Sale : Ms Dung 0918077755

E: dung.nguyen@vietthaiqua.com



Sale : Ms Dung 0918077755

E: dung.nguyen@vietthaiqua.com

